

HANDBOOK

Guide for Modern Insulation Testing



www.metrel.si

Metrel d.d.; Ljubljanska c. 77; SI -1354 Horjul; Slovenia

**Guide to modern
insulation testing**

Version 1.1, Code No. 20 750 784



1. Introduction	3
1.1 Purpose of the handbook »Guide to modern insulation testing«	3
1.2 Presentation of company METREL d.d. and its production program	4
2. The origin of insulation.....	5
2.1 Basics of insulation measurements	6
2.1.1 Surface leakage current I_{Riss}	7
2.1.2 Insulation leakage current I_{Riso}	7
2.1.3 Polarization absorption current I_{RCpi}	7
2.1.4 Capacitance charging current I_{Ciso}	7
2.1.5 Total current I_{tot}	8
2.2 Resume	9
3. Types of insulation testing	10
3.1 DC voltage testing and AC voltage testing	10
3.2 Spot reading test	11
3.3 Time rise method / polarization index / dielectric absorption	12
3.4 Dielectric discharge	14
3.5 Step voltage insulation resistance test.....	15
3.6 Withstanding voltage test	16
4. Test set-up	18
4.1 Safety considerations	18
4.2 Determination of tested devices	18
4.3 Discharging of capacitive objects after the test.....	21
4.4 Choosing appropriate test equipment.....	22
5. Typical problems during measurements.....	23
5.1 Result too low because of surface leakages, guarding techniques	23
5.2 Influence of temperature.....	24
5.3 Influence of humidity	26
5.4 Noisy environment, using filters.....	27
5.5 Instability because of high capacitive loads.....	29
5.6 Instability and accuracy problems of very high insulation results	30
5.7 Too-low result because of fixed wired and grounded objects	31
6. Typical connections for insulation resistance testing	32
6.1 Power cables.....	32
6.2 Control and communication cable	33
6.3 Wiring installation	35
6.4 Home appliances and similar electrical devices	35
6.5 Induction motor.....	36
6.6 Power transformer.....	37
7. Interpretation of results	39
8. Standards.....	41
9. Glossary.....	43
10. Recommended measurement instruments.....	45

1. Introduction

Insulation and leaking are two terms tied up to each other in the technical world. Insulation is a material property and is measured as insulation resistance. Leaking is measured as leakage current in general and is a result of voltage (tension) applied to insulation.

Characteristics of insulation tend to change through time, normally getting worse by ageing. Various physical phenomena have influence on insulation characteristics, like temperature, dirt, humidity, mechanical and electrical stresses, high-energy radiation, etc.

Safety, operability, and reliability are the most important parameters of electrical device containing insulation and this is the reason why insulation has to be measured.

Insulation is measured in the initiating phase of electrical device and also later during maintenance works or repairing, and measurements are of simple and diagnostic type.

1.1 Purpose of the handbook »Guide to modern insulation testing«

The intention of this handbook is to better acquaint the reader with the extensive problematic of insulation measurements.

The first part describes the basics of insulation measurement and terms that are regulating this field.

A special attention is given to terms and definitions that users of measuring equipment meet daily.

A special chapter is destined to the types of insulation testing. Another chapter covers typical problems during insulation measurement.

We hope that chapters are written in a short and understandable manner. We expect that this document will serve the reader as a groundwork whenever he will deal with terms, parameters or standards of this field.

The second part of the handbook acquaints the reader with the functions of METREL instruments. Presented are the most important connections for testing insulation resistance. The complete happening is shown, from the perception of the problem, the preparation and measurements itself, up to analysis and interpretation of final result.

The third and last part shortly presents existing METREL instruments for measuring of insulation (Electronic Insulation Tester MA 2060, TeraOhm 5kV MI 2077).

The glossary is given at the end of the book.

A more complete information can be given by visiting our web site or by your local METREL distributor.

The authors will be grateful for every comment or additional suggestions that would help us to supplement the handbook and METREL products.

This handbook together with user manuals of METREL instruments can be used for training on insulation measurement techniques, as well as for presentations of typical measuring instruments used today in the field of insulation measurements.

1.2 Presentation of company METREL d.d. and its production program

METREL, measuring and regulating equipment manufacturer has 42 years of experience in the development and production of measuring and regulating equipment. It is among the leading manufacturers and suppliers of test and measurement instruments for testing of safety on low-voltage electrical installations, earthing systems, testing of safety on machines and electrical appliances, instruments for measurement and testing of cable networks, as well as instruments for measurement, recording and analysing of power quality.

160 people are employed. There are 20 engineers involved in the R & D process.

One of the superior aspects of METREL is the speed at which it completes its development projects so that it takes at most 12 months from the idea to the production of the first series.

With regard to the construction of the test equipment, METREL has been linked up with University in Ljubljana and Ministry of science and technology. The results of our R & D activities are shown also in numerous patents registered, both at home and in other European countries.

New products produced by METREL are launched on the market every year. In 2004 there will be 6 new measurement instruments coming from the production line. Each product is checked by calibration laboratory after completing the production process and the relevant calibration certificates are enclosed. METREL Calibration laboratory is internationally approved.

METREL pays the greatest attention to the relationship with their partners and to the quality of its products. Certification to ISO 9001 has also been achieved and has been continuously maintained. The distribution network has been developed in most countries worldwide.

2. The origin of insulation

Modern technology brought us a lot of new materials, substances and other goods to make our life better and more comfortable. Electricity is one of them. However, many of these goods are useful only under control; otherwise, they are useless and could be dangerous. Common sense tells us that all these goods must be separated from surroundings – they must be insulated. For instance, to drive a car we have to drive gasoline within. We cannot imagine storing gasoline in a plastic bag. It must be stored in a special reservoir to prevent leaking. Gasoline must be reliably insulated from surroundings. The same is true with electricity.

Electricity is very useful as long as it is "kept" inside the cables, busbars, winding... If the electricity "escapes" from these items it becomes useless and very dangerous. This is the reason why any item that carries electrical current is covered with some type of insulation. The insulation restricts the flow of current between different conductors and between conductors and ground. The insulation must be just the opposite from the conductor. The conductor is usually made from copper or aluminium, which is known to be a good conductor of electric current. The insulation is usually made from non-metallic material. It should resist current and keep the current in the path along the conductor.

In theory, insulation does not carry electrical current. However, in reality we do not have an ideal insulation material. Every kind of insulation has some resistance. The insulation resistance is very high but it is not infinite.

Manufacturers of wires, cables, and motors have continually improved their insulation for service in industry, at home and other places, where electricity is being used. However, the insulation in service is subject to many effects which can cause it to fail: mechanical damage, vibration, excessive heat or cold, dirt, oil, and corrosive vapours moisture from air or technological process.

Combination of electrical stresses and degradation of insulation are at work as time goes on. As pinholes or cracks develop, moisture and foreign matter penetrate the surfaces of the insulation, providing the low resistance path for leakage current. Once started, different degradation processes tend to aid each other, permitting excessive current through the insulation.

The leaking current cannot be seen or smelt; only the consequences can be noticed - often too late.

Usually, however, a drop in insulation resistance is gradual, giving plenty of warning if checked periodically. Such checks permit planned reconditioning before service failure. If there are no checks, the electric device with poor insulation may be dangerous to touch when voltage is applied and it can also be completely destroyed. A sudden drop in insulation resistance is very rare, for instance when a device is flooded.

This is the reason why insulation-testing program should be carried out. A regular program of insulation resistance testing is strongly recommended to prevent electrical shocks, to assure safety of personnel, and to reduce out of service time. It helps to detect deterioration of insulation in order to schedule repair work such as: vacuum cleaning, steam cleaning, drying, and rewinding. It is also helpful for evaluating the quality of the repairs before the equipment is put back into operation.

2.1 Basics of insulation measurements

According to Ohms law,

$$I = \frac{U}{R} \tag{Eq. 1}$$

the current does not depend on time. But a simple measurement of insulation resistance will show us that the current depends on time. The reasons for such behaviour of the current are different phenomenas in an insulation material after a voltage is applied. A typical insulation model is presented in Figure 1. Figure 2 shows the time diagram of individual currents and the total (measured) current.

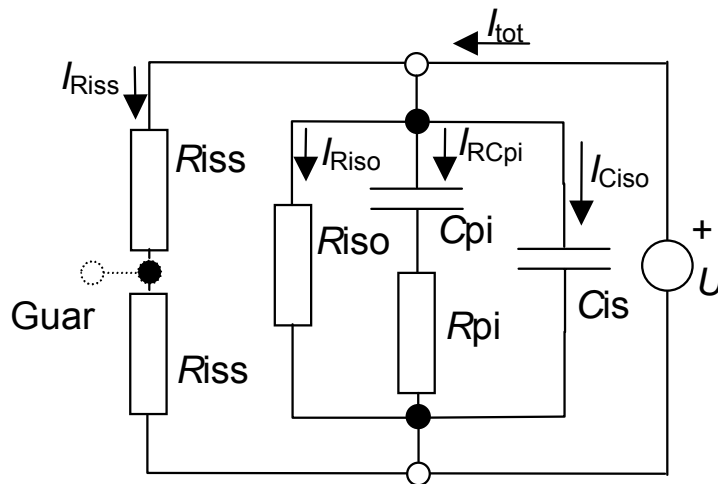

Figure 1: Insulation resistance and capacitance model, partial and total currents

U	Applied test voltage
R_{iss1} and R_{iss2}	Surface leakage resistances
R_{iso}	Insulation resistance
C_{iso}	Insulation capacitance
R_{pi}	Polarization resistance
C_{pi}	Polarization capacitance

The total current I_{tot} comprises of four partial currents.

I_{tot}	Total current
I_{Riss}	Surface leakage current
I_{Riso}	Insulation leakage current
I_{RCpi}	Polarization absorption current
I_{Ciso}	Capacitance charging current

2.1.1 Surface leakage current $I_{R_{iss}}$

Surface leakage current flows on the surface of insulation between connection points of applied voltage. This current causes an error in insulation resistance measurement and could be eliminated by using a guard terminal. According to Figure 1 it flows through resistors R_{iss1} and R_{iss2} . The current does not depend on time.

$$I_{R_{iss}} = \frac{U}{R_{iss1} + R_{iss2}} \quad \text{Eq. 2}$$

2.1.2 Insulation leakage current $I_{R_{iso}}$

This current flows through insulation. The insulation resists with resistance R_{iso} (Figure 1). The insulation leakage current does not depend on time.

$$I_{R_{iso}} = \frac{U}{R_{iso}} \quad \text{Eq. 3}$$

2.1.3 Polarization absorption current $I_{R_{Cpi}}$

The absorption or de-absorption current starts from a lower level than capacitance charging current but has a much longer time constant (up to several minutes). This is caused by ions and dipoles re-aligning themselves within the insulation. When an electric field is applied some ions are able to move, and some dipoles align themselves within the field. These effects reverse themselves slowly when the test voltage is removed, caused by particles returning to their natural random state. In the model this phenomena is represented as an additional $R_{pi} - C_{pi}$ combination in parallel with R_{iso} . The current $I_{R_{Cpi}}$ charges the capacitor C_{pi} . At the beginning the capacitor is not charged, i.e. no polarized insulator, and the current starts with value U/R_{pi} . The capacitor starts to charge and the current becomes smaller. Finally the capacitor is completely charged, i.e., the insulator completely polarized, and the current does not flow any more. The polarization absorption current depends on time according to Equation 4.

$$I_{R_{Cpi}} = \frac{U}{R_{pi}} e^{-\frac{t}{R_{pi}C_{pi}}} \quad \text{Eq. 4}$$

Other currents could mask the polarization absorption current; therefore, the polarization current measurement could be problematic.

It is often easier to measure the opposite process: the dielectric discharge. In this case the measurement starts with fully charged capacitor C_{pi} . The connection leads are shorted and the depolarization current is observed.

2.1.4 Capacitance charging current $I_{C_{iso}}$

The capacitance charging current $I_{C_{iso}}$ charges the capacitor C_{iso} . C_{iso} represents the capacitance between metal parts connected to the measuring instrument inputs that are

separated with tested insulation. Only the test instrument internal resistance limits the I_{Ciso} .

$$I_{Ciso} = \frac{U}{R_{int}} e^{-\frac{t}{R_{int}C_{iso}}} \tag{Eq. 5}$$

R_{int} is internal resistance of test source.

At the beginning the capacitor is not charged and high current is flowing. The current drops as the capacitor is being charged.

2.1.5 Total current I_{tot}

The sum of all presented currents represents the total current:

$$I_{tot} = I_{Riss} + I_{Riso} + I_{RCpi} + I_{Ciso} \tag{Eq. 6}$$

Figure 2 shows time diagram of the currents based on the standard insulation model presented in Figure 1.

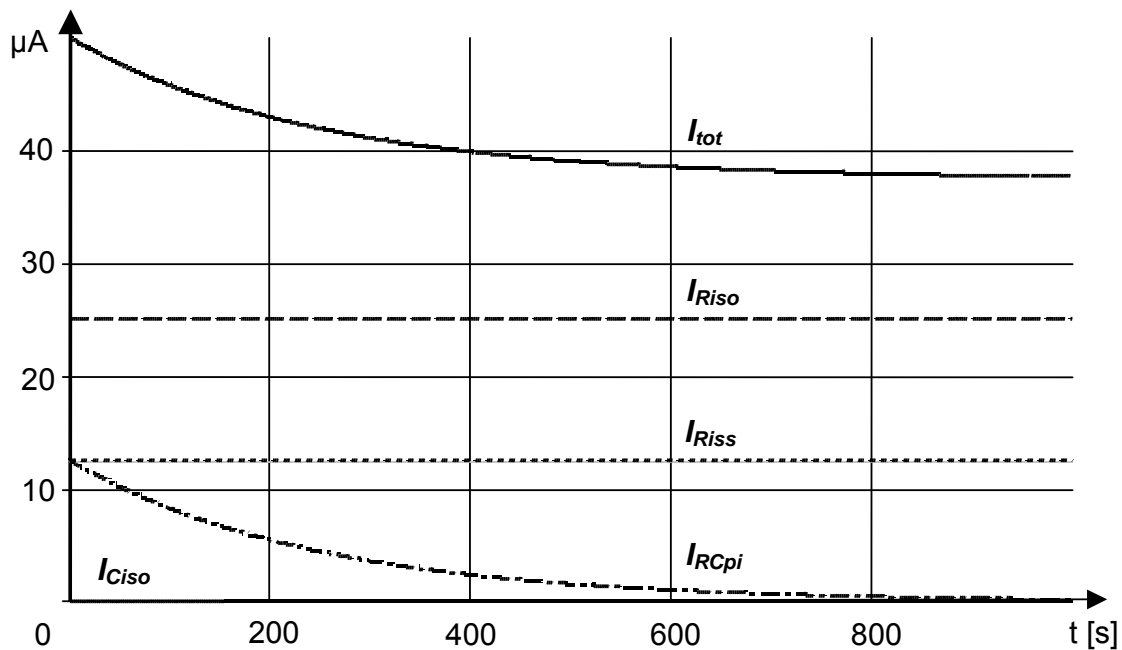

Figure 2: Current diagram for an ideal voltage source

In practice the insulation resistance measurement instrument does not include an ideal voltage source. The available power is limited. Because of this the current/time diagram is changed compared to Figure 2. At the start all available instrument power is used to charge the capacitor C_{iso} for short period. The voltage on connection points drops because of this. These phenomena reshape the ideal curves to real current curves as shown in Figure 3.

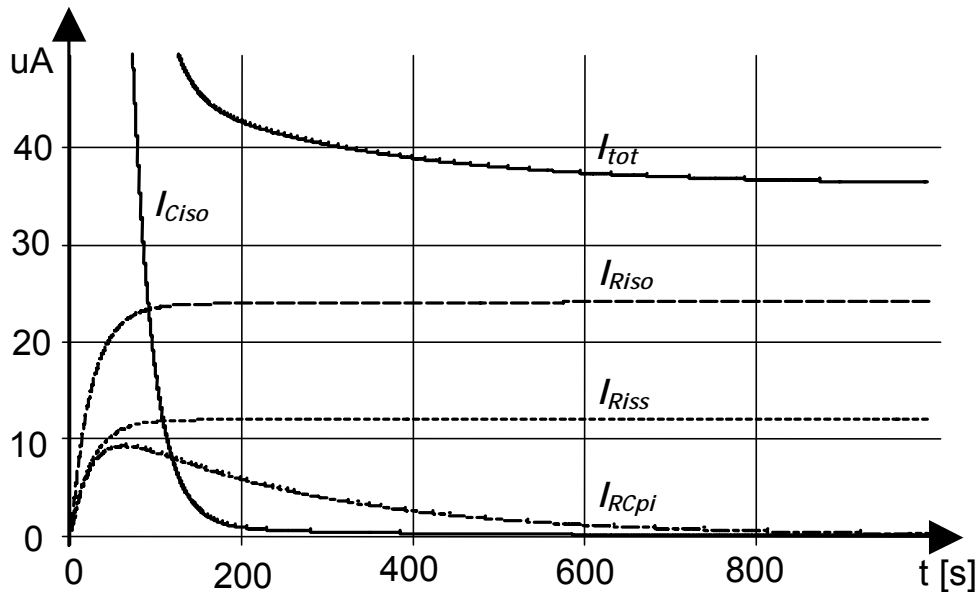

Figure 3: Typical current/time diagram for a real voltage source

2.2 Resume

When DC voltage of an insulation test instrument is suddenly applied to the insulation, the test current will start at a high value, gradually decrease with time, and finally level off to a stable value. Low initial insulation resistance is partly caused by high initial capacitance charging current. This capacitance current rapidly decreases to a negligible value (usually within 15 s) when the insulation is charged.

The low initial insulation resistance is also partly caused by high initial polarization absorption current. This current also decreases with time, but more gradually, requiring from 10 minutes to several hours to decay to a negligible value. However, for the purpose of testing the change in dielectric absorption current can be disregarded after 10 minutes. The leakage current does not change with time, and this current is the primary factor on which the insulation quality may be judged. Insulation resistance varies directly with the thickness and inversely with the area of the insulation being tested.

3. Types of insulation testing

Various types of insulation testing were developed to determine insulation characteristics. This chapter describes some of the most frequently used measuring methods.

3.1 DC voltage testing and AC voltage testing

Until now testing with DC voltage has been presented but AC testing of insulation is also possible. In this case we need an AC high voltage source. The voltage is changing and the instrument must provide AC current for charging and discharging the capacitor C_{iso} . The current through the capacitor increases, and its impedance decreases with increasing the frequency.

Usually only a minor part of the total current will flow through other components.

$$I_{C_{iso}} = U_{AC} \cdot 2\pi f \cdot C_{iso} \quad I_{C_{iso}} \cong I_{tot} \quad \text{Eq. 7}$$

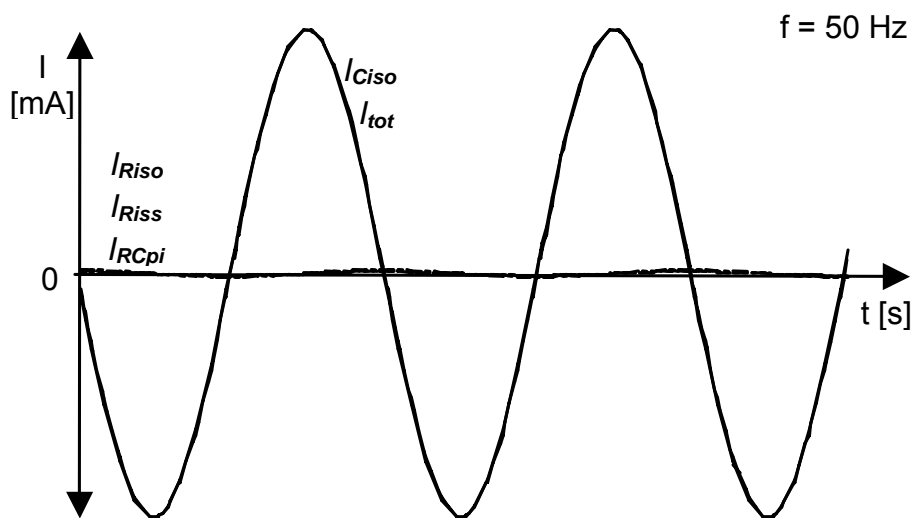

Figure 4: AC currents in insulation model from Figure 1 when testing with AC voltage

In general the polarization absorption or leakage currents give us useful information. When testing with an AC source this information could be lost due to the high charging / discharging current which is extremely large compared to the leakage and polarization absorption current.

High voltage testing with powerful AC sources is often used for performing withstanding or dielectric tests. The voltage is increased to some specified point to see if the insulation can stand that particular voltage. For AC withstanding voltage test the source must be capable to generate enough current which flows through insulation capacitance C_{iso} .

Sometimes AC testing may be more suitable for proof testing of equipment that either passes or fails the test. However, a DC test will always give you more qualitative picture about the tested insulation.

3.2 Spot reading test

This is the simplest and fastest way of insulation resistance testing. Unfortunately only one test, with no prior tests, can be only a rough guide as to how good or bad the insulation is. In this test the instrument is connected across the insulation of the tested item. A test voltage is applied for a fixed period of time, usually a reading is taken after 1 minute as can be seen in Figure 5.

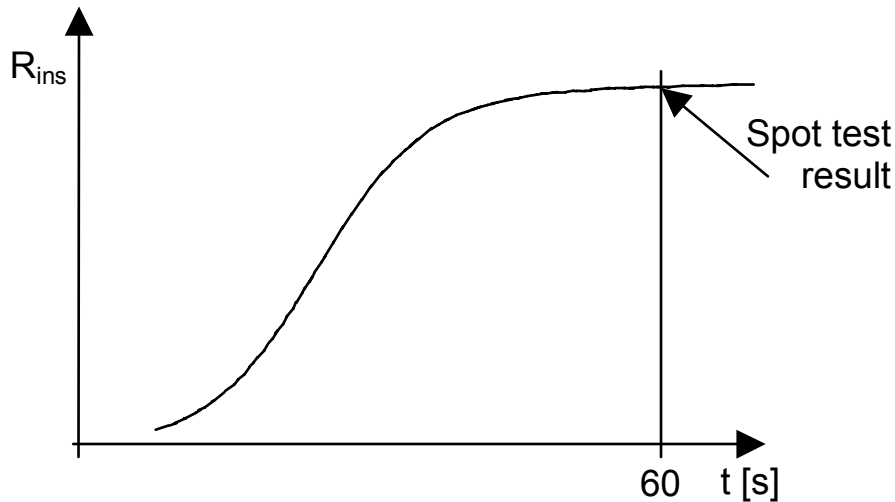

Figure 5: Typical insulation resistance/time diagram for a spot reading test

The spot reading test should only be carried out when the insulation temperature is above the dew point. The temperature of insulation is also very important data, because the reading should be corrected to the working temperature. The reason for this is that working temperature of tested insulation is normally higher than the ambient temperature and for safety reasons the resistance should be corrected to the temperature of working condition. For more information see chapter 5.2. *Influence of temperature.*

The corrected insulation resistance readings should be recorded for comparison over time. If a downward trend is observed, look for dirt or moisture. A very sharp drop of insulation resistance indicates an insulation failure.

As mentioned before, one spot-reading test gives us only a rough guide about insulation condition.

For not critical application areas the spot reading test is enough.

Hint

The lower limit of insulation resistance may often be established according to **the one mega-ohm rule**:

Insulation resistance should be at least one mega-ohm for each kilovolt of operating voltage, but not less than one mega-ohm.

For example, a motor rated at 5 kV working voltage should have a minimum resistance of 5 MΩ.

Some further recommendations:

IEEE 43-2000 (Recommended Practice for Testing Insulation Resistance of Rotating Machinery):

- $1\text{ M}\Omega + 1\text{ M}\Omega / 1000\text{ V}$ rating of equipment for insulation systems prior to 1970
- $5\text{ M}\Omega$ for random wound motors under 600 Volts
- $100\text{ M}\Omega$ for form wound motors, motors over 600 Volts, and armatures.

IEC 60439-1 (Low-voltage switchgear and controlgear assemblies - Part 1: Type-tested and partially type-tested assemblies):

- *Scope of the insulation resistance test: alternative method for verification of dielectric properties by insulation resistance measurement*
- *Description: a d.c. test voltage (500 V) is applied to the insulation and its resistance is measured. Insulation is proper, if its resistance is high enough ($1000\ \Omega / \text{V}$ of circuit rated voltage).*

IEC 61558 (Isolating transformers and safety isolating transformers):

- *Test voltage: 500 V, measurement period: 1 min*
- *Minimum insulation resistance for basic insulation: $2\text{ M}\Omega$*
- *Minimum insulation resistance for supplementary insulation: $5\text{ M}\Omega$*
- *Minimum insulation resistance for reinforced insulation: $7\text{ M}\Omega$*

3.3 Time rise method / polarization index / dielectric absorption

Let us go back to Figures 2 and 3. It can be seen that a bad insulation causes drop of the value R_{iso} and the increasing in the insulation leakage current I_{Riso} . The absorption current is masked by a high insulation leakage current. The insulation leakage current stays at a fairly constant value and the resistance reading stays low (Figure 6).

A good insulation shows continuous increasing of the resistance over a period. This is caused by the absorption that can be clearly seen. The absorption effect lasts far longer than the time required for charging the capacitance of the insulation.

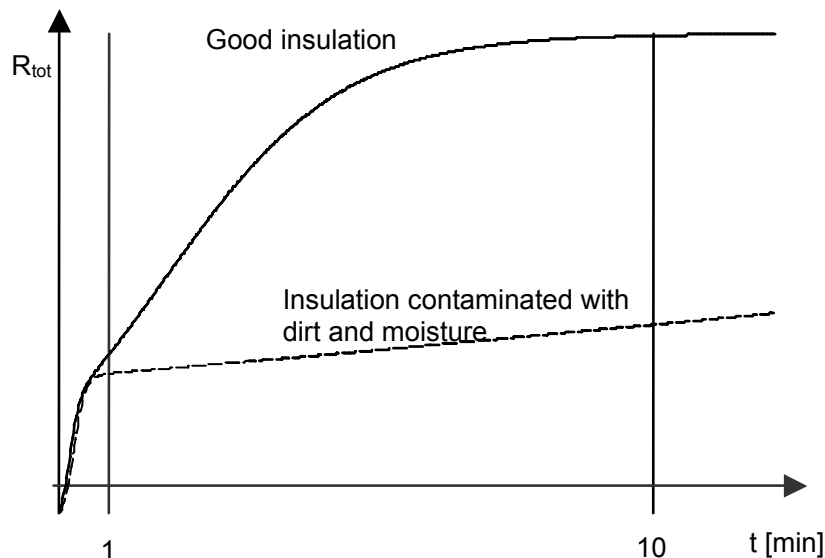

Figure 6: Time diagrams of good and bad insulation tested with the time-rise method

The results of this method do not depend on temperature and the method can give you conclusive information without comparing records of past tests. The result of time rise method is not the insulation resistance but only the ratio between two readings at a different time. The influence of temperature is the same at both measurements; therefore, the temperature has no effect on results of time rise method.

This test method is sometimes referred to as **absorption test**. The result of this measurement is polarization index.

The **polarization index (PI)** is defined as the ratio of measured resistance in two time slots. The most typical ratio is 10 min value to 1 min value at a continuous insulation resistance measurement, but this is not a rule.

$$PI = \frac{R_{\text{tot}}(10 \text{ min})}{R_{\text{tot}}(1 \text{ min})} \quad \text{Eq. 8}$$

A good insulation has a small leakage current and the total current decreases slowly. Therefore, the polarization index of good insulation is high. A contaminated or damaged insulation has low polarization index because of high and constant leakage currents.

General applicable values of polarization index are shown in table 1.

PI value	Tested material status
1 to 1.5	Not acceptable (older types)
2 to 4 (typically 3)	Considered as good insulation (older types)
4 (very high insulation resistance)	Modern type of good insulation systems

Table 1: Typical values of polarization index

The PI test is very useful for testing old types of insulations like oiled paper where the one-minute resistance from the spot reading is relatively small.

The PI test could be disregarded if the 1-minute insulation resistance is > 5000 MΩ.

Dielectric absorption ratio (DAR) is similar to the polarization index method for time rise testing of the insulation. The only difference are periods for capturing the results. Periods are shorter and the first result is captured at 30 s and the second at 1 minute.

$$DAR = \frac{R_{\text{tot}}(1 \text{ min})}{R_{\text{tot}}(30 \text{ s})} \quad \text{Eq. 9}$$

General applicable values for dielectric discharge are shown in table 2.

DAR value	Tested material status
< 1	Bad insulation
1 ≤ DAR ≤ 1.25	Acceptable insulation
> 1.4	Very good insulation

Table 2: Typical values for dielectric discharge

Note:

- When polarization index for random insulation is 2 or less even for new materials the dielectric absorption test can be used. A minimum DAR value 1.25 is required as opposed to at least 2 for PI.

3.4 Dielectric discharge

Different currents are flowing through the insulation when a test voltage is applied (surface leakage current - I_{Riss} , insulation leakage current I_{Riso} , polarization absorption current I_{RCpi} , capacitance charging current I_{Ciso}). It is difficult to determine the polarization index if I_{RCpi} is small compared to the others.

Rather than measuring the polarization current during an insulation test, the **dielectric discharge (DD)** test can be performed (Figure 7).

The device under test must be completely charged to make sure that the polarization process is finished. The only remaining current component is insulation leakage current and the resistance readings are stable.

After the voltage is switched off the device under test is discharged and the current is measured. Usually the current value after one minute is taken into the DD result. This current depends on the overall capacitance and the test voltage. The capacitance can also be measured during the discharging phase.

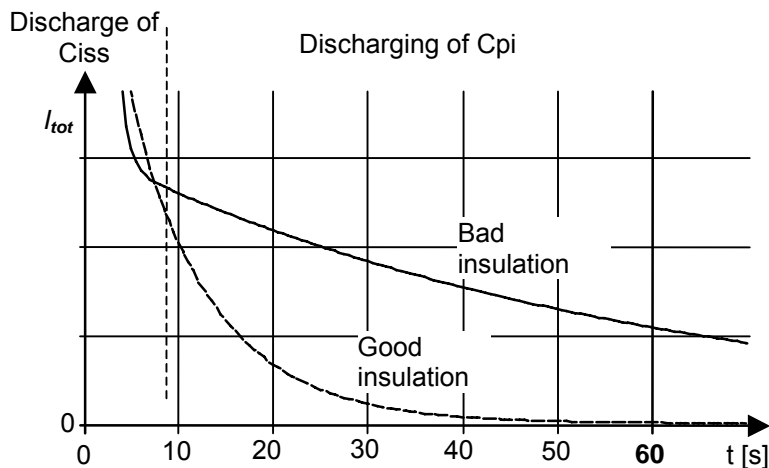

Figure 7: The current/time diagram of a good and bad insulation tested with dielectric discharge method

Dielectric discharge is calculated according to equation 10:

$$DD = \frac{I_{dis}(1min)}{U \cdot C_{iso}} \tag{Eq. 10}$$

where:

- $I_{dis}(1min)$ discharging current measured 1 min after the voltage was switched off
- U test voltage
- C_{iso} capacitance of tested object

A high re-absorption current shows that the insulation has been contaminated, usually by moisture. Typical values of dielectric discharge are shown in table.

<i>DD value</i>	<i>Tested material status</i>
> 4	bad
2 - 4	critical
< 2	good

Table 3: Values of dielectric discharge

The dielectric discharge test is very useful for testing a multi-layer insulation. This test can identify excess discharge currents that occur when one layer of a multi-layer insulation is damaged or contaminated. This condition will not be detected by both the spot test and the polarization index test. Discharge current will be higher for known voltage and capacitance if an internal layer is damaged. The time constant of this individual layer will differ from other layers, causing a higher current than that of a sound insulation.

3.5 Step voltage insulation resistance test

According to Figures 2 and 3 the insulation resistance R_{iso} does not depend on voltage. But in practice this happens quite often. Testing with a voltage far below the one expected in service often reveals moisture and dirt in insulation, whereas effects of ageing or mechanical damage of a fairly clean and dry insulation may not be revealed at such low stress. The step voltage method is very useful when testing with an instrument that has a lower test voltage than the rated test voltage of the tested item. In other words, step voltage test gives us useful results even in case we are not able to stress insulation with nominal electrical voltages.

The influence of local weak spots is small at low voltage, but rapidly increases by increasing the test voltage. A rapidly decreasing insulation resistance indicates this process.

The step voltage measurement is simple. The device under test is exposed to different test voltages that are applied in steps. The voltage starts at the lowest value and increases with defined steps up to the highest level. Figure 8 shows an example of a step voltage test with five voltage steps and five equal time periods. The recommended ratio for the test voltage steps is 1 to 5. At each step, test voltage should be applied for the same length of time T which is usually 60 s. The application of increased voltage creates electrical stresses on internal insulation cracks. Results can also be corrected to working temperature. For more information see chapter 5.2. *Influence of temperature.*

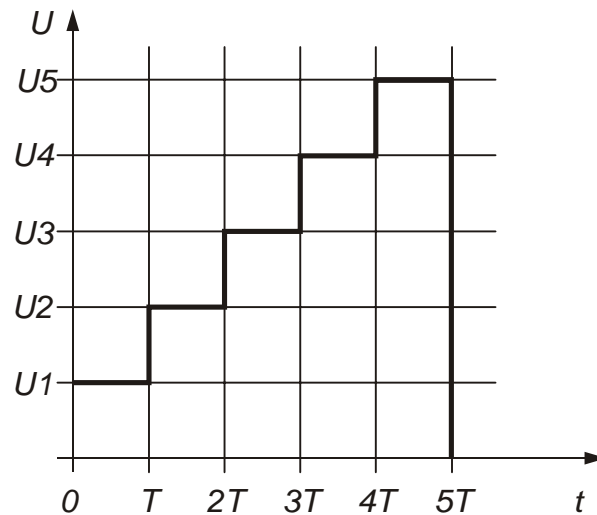

Figure 8: Typical measuring procedure for step voltage measurement.

The result is a curve that shows insulation resistance depending on test voltage.

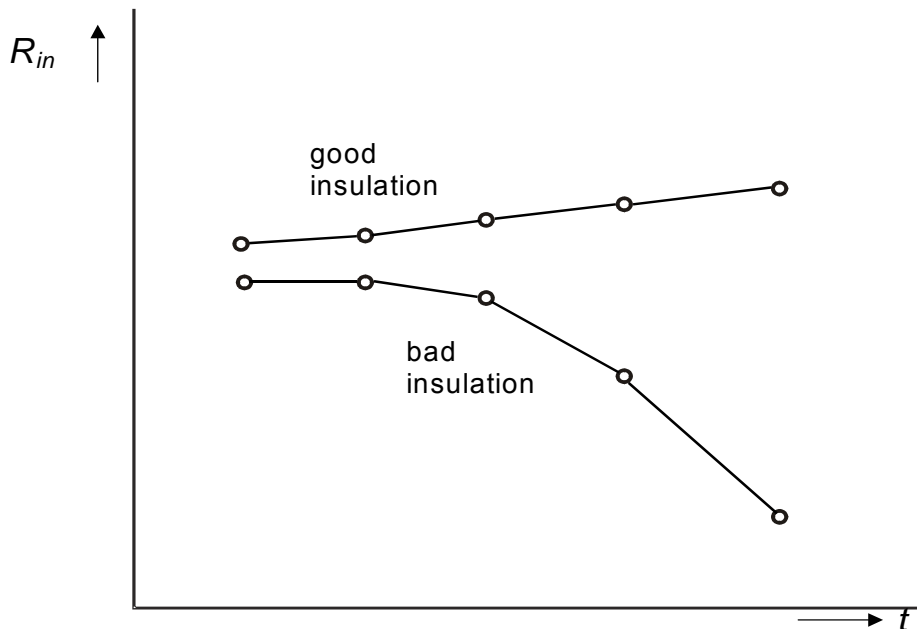

Figure 9: Typical step voltage measurement results

The shape of the curve represents the quality of insulation:

- The resistance of a damaged insulation will rapidly decrease.
- A good insulation has approximately constant resistance at all voltages.

3.6 Withstanding voltage test

The withstanding voltage test is one of the basic insulation tests. Its principle is very simple - the voltage is stressing the device under test until the required test time or breakdown of insulation is reached (Figure 10). The time gradient of increasing voltage, maximum voltage and the time of maximum test voltage are very important and depend

on the type of device under test. These parameters are defined in adequate standards. The indication of a breakdown is a sudden increase in the current through insulation, beyond the predefined limit.

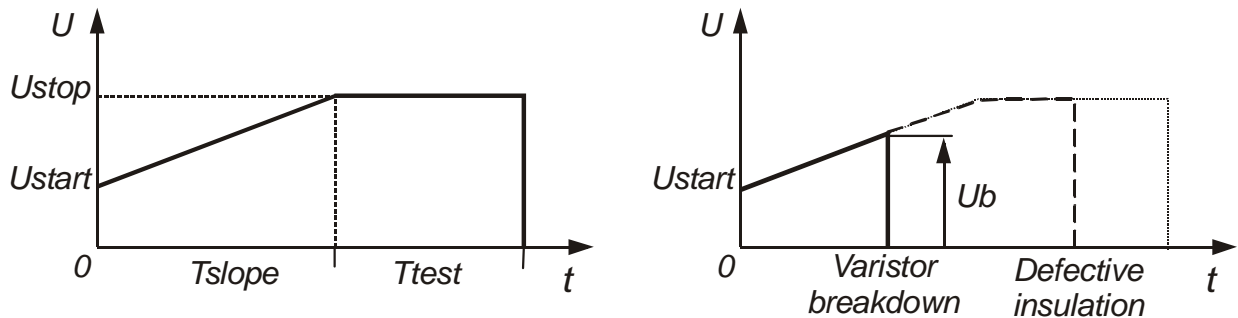

Figure 10: Measuring procedure for withstanding voltage measurement.

This test covers two types of tests:

- a) DC withstanding voltage test for insulation coordination purposes. Keeping the voltage for the predefined period performs this test. The device under test must withstand this voltage without breakdown of the insulation.

In this case the slope of increasing voltage must be low enough to prevent breakdown indication due to charging current of tested object capacitance. Test time with defined test voltage is usually 1 min for type tests and 2 s to 10 s for routine tests. Tested insulation passes test if neither breakdown nor flashover occurs.

- b) Breakdown voltage testing of voltage limiting device, e.g. transient suppressors. This test is similar to DC withstanding voltage test except that the test voltage is slowly increasing until the breakdown of the tested device occurs. Rated voltage for most transient suppressors is defined at threshold current of 1 mA.

4. Test set-up

4.1 Safety considerations

Test set-up must be prepared carefully and correctly to prevent damage on the tested device, measuring instrument and to protect the operator. The following steps must be carried out:

A) To protect device under test (DUT) and test equipment:

- Take the DUT out of service and shut it down.
- Check that the DUT is disconnected from other equipment and circuits if possible.
- Discharge the insulations that will be tested (METREL testers will give a warning in case of energized DUT).
- To prevent the damage of the DUT it is recommended to short accessible connections of circuit on both sides of tested insulation.
- Select correct test voltage and method.
- Pay attention to grounded DUT. Some insulation testers are also connected to ground potential (normally negative pole) that can lead to improper results.

B) To protect the operator:

- Use appropriate test accessories – test leads, alligators, test tips, etc. The accessories must be intrinsically safe for required test conditions.
- Reject test equipment and accessories with noticed cracks, breaks, and/or damaged insulation.
- Fix the connection before starting the measurement.
- Pay attention that the voltage source of insulation tester is current limited beyond 3.5 mA.
- Tested insulation capacitance C_{iso} could be high enough to become hazardous live when charged to high voltage. For more information refer to chapter 4.3. *Discharging of capacitive objects after the test.*
- Select threshold current limit as low as possible.
- Don't touch any part of the test system during the measurement and do not disconnect test leads until the measurement is finished and the DUT discharged.
- METREL test equipment makes automatic discharge of the test circuit at the end of the test.

4.2 Determination of tested devices

Operator must know what and how to test. In general, the insulation of each individual circuit of DUT must be tested against the rest of the circuits.

Simple device

An example for a simple device like electric heater is shown in Figure 11. The insulation that has to be tested lies between the heating core and metallic enclosure including the insulation of supply cord. Required are the insulation resistance and the withstanding voltage tests.

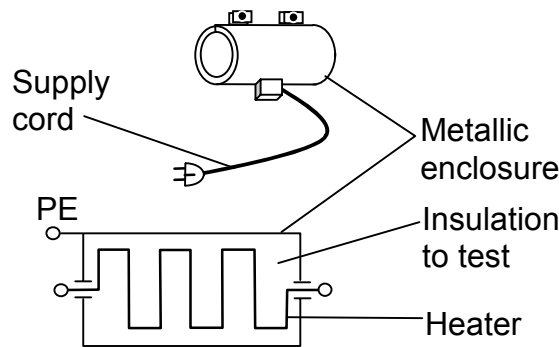

Figure 11: Example of electric heater with definition of insulation to test

As in the example of the electric heating device at least one insulation shall be tested. However, in most cases more than two circuits are separated in a single device and/or two and more devices are configured in a system.

Complex device

Figure 12 represents a typical device with more than two separated circuits, like machine control unit, electronic equipment, etc.

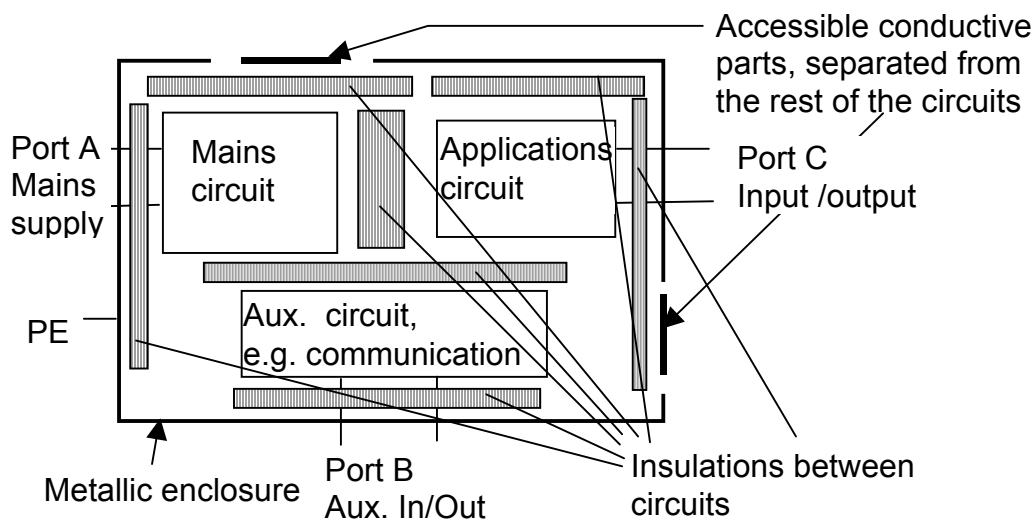

Figure 12: Determination of insulations

The device on Figure 12 consists of:

- Mains part (primary side of transformer, fuses, filters, switches, mains cord) with its port A,
- Application circuit with port B (e.g. step motor driver),
- Separated auxiliary circuit with port C (low voltage input/output ports, communication to a PC),
- Metallic enclosure, and
- Additional conductive accessible parts (knobs, handles, etc.) separated from all other circuits.

List of insulations between circuits from Figure 12:

<p>Mains circuit to: Metallic enclosure Accessible conductive parts separated from enclosure Application circuit Aux. circuit</p>	<p>Applications circuit to: Metallic enclosure Accessible conductive parts separated from enclosure Aux. circuit</p>	<p>Aux. circuit to: Metallic enclosure Accessible conductive parts separated from enclosure</p>
--	--	--

To test, e.g. the insulation between mains and application circuits, the voltage between port A and port C shall be applied. Note that all insulations are not tested to the same condition but according to application conditions. The insulations against mains circuit are considered as most important.

A system with two or more devices

The system (Figure 13) represents two or more devices connected to each other. If we want to measure only one device, it must be disconnected from the network and other devices.

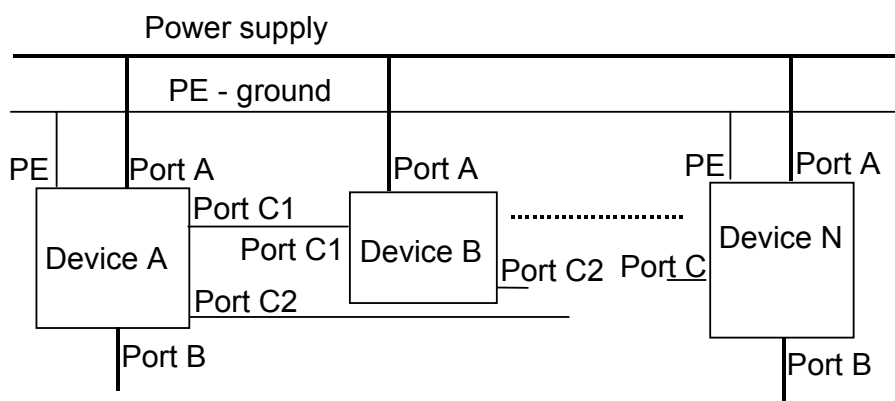

Figure 13: A system of connected devices represented in Figure 12

If disconnection is difficult or expensive, the connected equipment which will be included in the test must be determined. Pay particular attention to conductors that lead away from the device under test. Leakage currents flow through every single device included in the test. The total current is the sum of individual leakage currents. Therefore, the more equipment is included in a test, the lower the measured insulation resistance will be.

So, the insulation resistance of the tested device is the same or higher than the measured insulation resistance.

If the measured resistance is high enough, further separation of device under test is pointless. This method is useful especially for a spot test. If the measured resistance is too low, further tests have to be done. In that case it is necessary to separate the component parts. Individual parts must be tested separately.

In general, it is recommended to make a test of the complete system. This information will be very useful for future inspections. The separation of the components may not be necessary unless too low readings will be observed.

4.3 Discharging of capacitive objects after the test

Note that capacitor of 45 nF charged to 1 kV or capacitor of 8 nF charged to 5 kV are hazardous live!

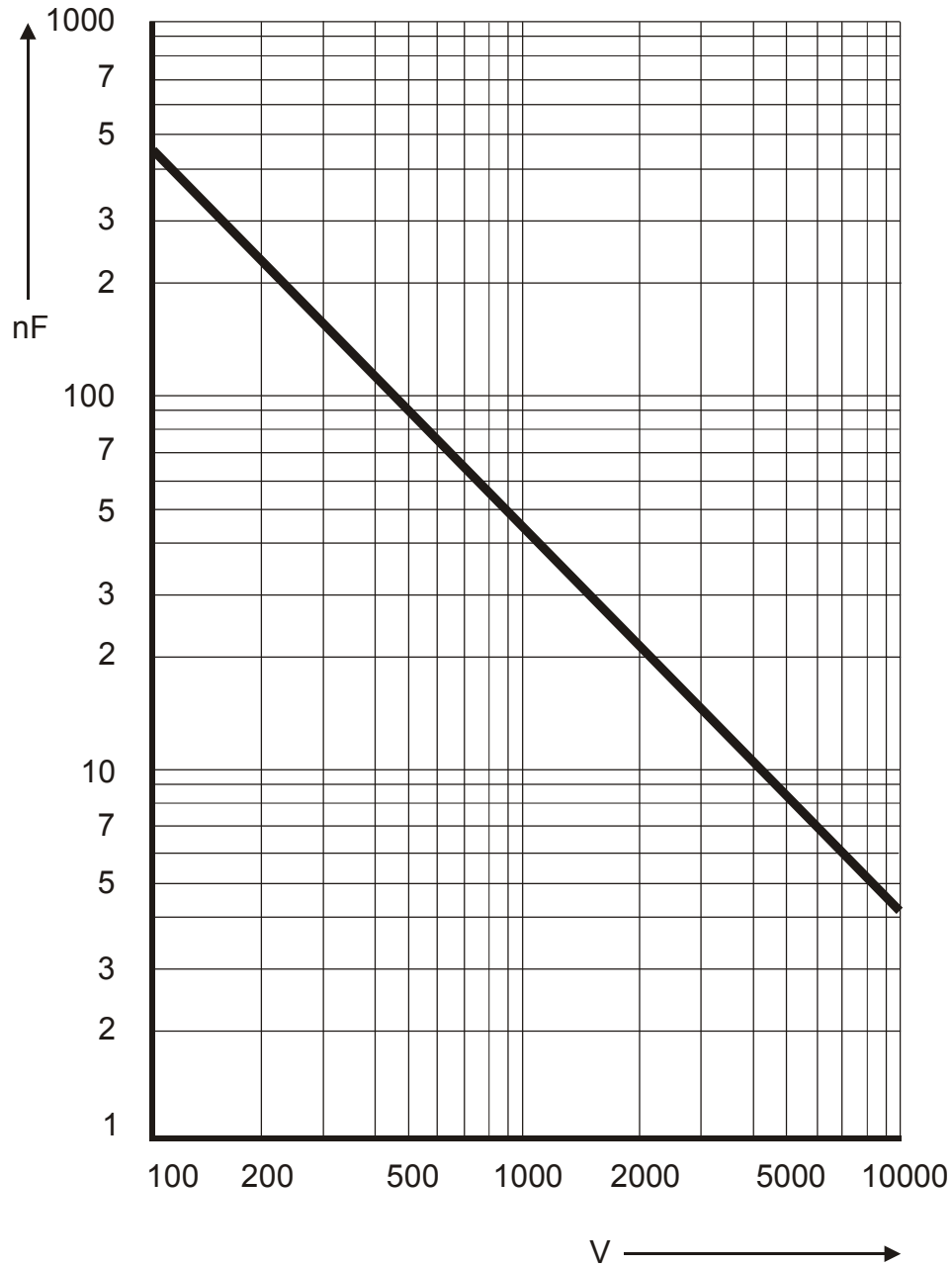

Figure 14: Maximum safe capacitance of tested insulation versus test voltage

Safety limit form IEC 61010-1 for charged capacitance:

- 45 μC for test voltage less than 15 kV (see Figure 14) and
- 350 mJ for higher voltage.

Never touch the measured item during testing until it is totally discharged – modern test instruments perform a complete automatic discharge after each test and give indication until the discharge is finished.

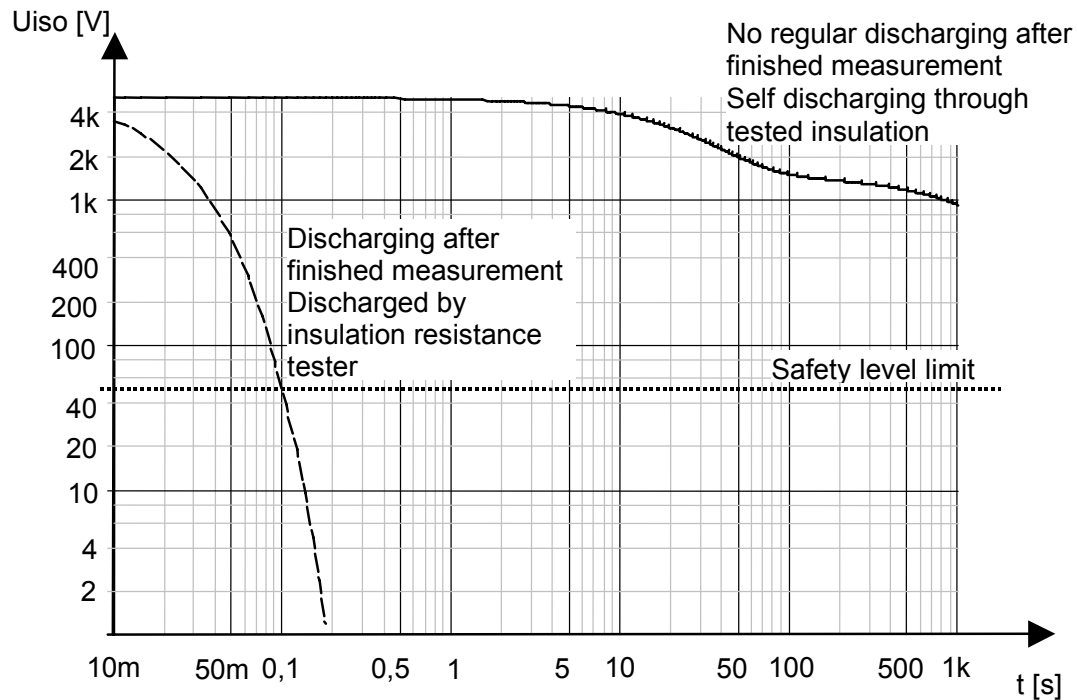

Figure 15: Discharging of insulating material ($C_{iso} = 100 \text{ nF}$, $U_{test} = 5 \text{ kV}$)

Figure 15 shows that it takes time to discharge a high capacitive tested object. It is very important not to disconnect the measuring leads until the discharge is completed.

Note:

Typical high capacitive measuring objects are long cables or electrical equipment with input EMC filter capacitors.

4.4 Choosing appropriate test equipment

Various types of insulation testers exist on the market. Refer to the table of METREL test instruments for the instrument that best suits your application.

5. Typical problems during measurements

This chapter describes different problems that often occur when performing insulation tests.

Each problem is described and possible solutions are presented.

Most common problems are:

1. Result too low because of surface leakages
2. Drifting because of temperature
3. Drifting because of humidity
4. Inductive and capacitive coupling of external disturbing/noise signals
5. Instability because of high capacitive loads like long cables
6. Instability and accuracy problems of very high insulation results
7. Result too low because of ground and other leakages

5.1 Result too low because of surface leakages, guarding techniques

The influence of the surface leakage can be shown on the basic insulation model (Figure 1). The quality of insulation is represented by the leakage current I_{Riso} , but there are also other partial currents: surface leakage current I_{Riss} , polarization absorption current I_{RCpi} and capacitance charging current I_{Ciso} .

The polarization absorption current and the capacitance charging current are decreasing with time to zero level but the surface leakage current is not. To eliminate the influence of surface leakage current we need a third terminal, the so-called guard terminal.

Using the GUARD terminal

The guard terminal must be connected in the path of the surface leakage current as shown in Figure 1 and Figure 16.

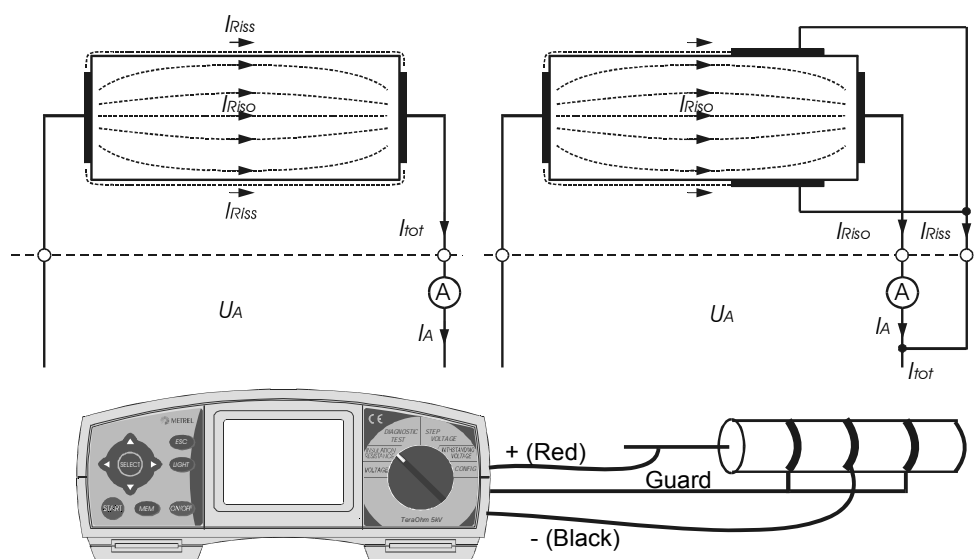

Figure 16: Connection of the GUARD terminal to the measured object (an example for measuring cable insulation is shown)

U_A	Applied test voltage
I_{Riss}	Surface Leakage current (caused by surface dirt and moisture)
I_{Riso}	Current through actual insulation
I_A	Current through the A-meter, considered in the result.

The guard terminal is at the same potential as the negative terminal. Since the leakage resistance is effectively in parallel with the resistance to be measured, the use of guard terminal causes the current flowing through surface to be diverted from the measuring circuit. The unwanted surface leakages are drained by the guard terminal and are not considered in the measuring result.

Result without using the GUARD terminal:

$$I_A = I_{Riso} + I_{Riss} \quad \text{Eq. 11}$$

The result is incorrect.

Result using GUARD terminal:

$$I_A = I_{Riso} \quad \text{Eq. 12}$$

The result is correct.

In general, the surface leakage current influence becomes effective when the measuring insulations are above 10 G Ω . It is recommended to use the guard terminal in this case.

5.2 Influence of temperature

An increase in temperature causes a decrease of the insulation resistance. Therefore, the temperature has a high influence on insulation resistance readings and the results should be corrected to a base temperature. The base temperature should be 20 °C, but in most cases working temperature of tested insulation is taken. The following reasons support this procedure:

- the working temperature is normally higher than ambient temperature, which results in lower insulation resistance that could lead to excessive leakage currents and degraded safety – insulation is still good in cold state.
- traceability of results through periodic testing – results are calculated to the base temperature and graphical presentation of these results shows degradation of the insulation in time. This is helpful information in deciding when it is necessary to replace insulation.

The correction factors depend on the type of insulation. To simplify the corrections, the correction factors for different insulation materials have been developed. Table 11 shows correction factors for typical insulators that are used in rotating equipment, transformers, and cables.

To get a result corrected to the base temperature, the readings must be multiplied by the factor corresponding to the ambient temperature.

Table 11: Temperature correction factors for insulation resistance

temperature (° C)	Rotating equipment		oil-filled transformers	cables							
	class A	class B		code natural	code GR-S	performance natural	heat resist natural	heat resist perform. GR-S	ozone resist natural GR-S	varnished cambric	impregnated paper
0	0,21	0,4	0,25	0,25	0,12	0,47	0,42	0,22	0,14	0,1	0,28
5	0,31	0,5	0,36	0,4	0,23	0,6	0,56	0,37	0,26	0,2	0,43
10	0,45	0,63	0,5	0,61	0,46	0,76	0,73	0,58	0,49	0,43	0,64
15,6	0,71	0,81	0,74	1	1	1	1	1	1	1	1
20	1	1	1	1,47	1,83	1,24	1,28	1,53	1,75	1,94	1,43
25	1,48	1,25	1,4	2,27	3,67	1,58	1,68	2,48	3,29	4,08	2,17
30	2,2	1,58	1,98	3,52	7,32	2	2,24	4,03	6,20	8,62	3,2
35	3,24	2	2,8	5,45	14,6	2,55	2,93	6,53	11,65	18,2	4,77
40	4,8	2,5	3,95	8,45	29,2	3,26	3,85	10,7	25	38,5	7,15
45	7,1	3,15	5,6	13,1	54	4,15	5,08	17,1	41,4	81	10,7
50	10,45	3,98	7,85	20	116	5,29	6,72	27,85	78	170	16
55	15,5	5	11,2			6,72	8,83	45		345	24
60	22,8	6,3	15,85			8,58	11,62	73		775	36
65	34	7,9	22,4				15,40	118			
70	50	10	31,75				20,30	193			
75	74	12,6	44,7				26,6	313			

Example:

A motor with class A insulation has a winding temperature of 40 °C. The result of measurement at this temperature is 2 MΩ.

The value of resistance corrected to 20 °C:

$$R_{20} = R_{40} \cdot k_{40} = 2\text{M}\Omega \cdot 4,8 = 9,6\text{M}\Omega$$

Eq. 13

Hint

For a very rough estimation the correction can be made by the following thumb rule: For every 10 °C increase in temperature halve the resistance; or for every 10 °C decrease double the resistance.

Notes

- The temperature correction is especially important for spot testing.
- The time-resistance and step voltage method are relatively independent of temperature effects.
- Measuring instruments are also influenced by temperature. In general the measuring error is small compared to the change of insulation resistance for the same change of temperature. More information can be found in technical specification.

5.3 Influence of humidity

The humidity of surrounding air could affect insulation resistance. But the effect of humidity also depends on ambient temperature. Very important is the dew-point temperature. This is the temperature at which the moisture vapour in air condenses as a liquid. If the device under test operates above the dew-point temperature, the results of the test will not be affected much by humidity. When the temperature decreases under the dew point the condensed moist from surrounding air does affect the results of the test. When we are testing an outdoor operating device it is recommended to make a note about weather conditions during the test. The operator must be very careful with small portable devices. If the tested device has been brought from a cold place into a warm place just before the test, the results will not be adequate. This is only one of the reasons why the device under test should not be moved just before the test and the temperature of surroundings should not change before and during the test.

Without the dew-point measurement it is very hard to define if the temperature exceeds the dew-point or not. If the dew can be seen it is a clear sign that temperature is much under the dew-point, and the effects of dew will appear. However, if the temperature is just under the dew-point we can not see the dew, but the process of condensation starts on dust, in cracks, and in breaks of insulation. The only solution is the dew-point measurement that will give you a clue as to whether such invisible conditions exist, altering the test results.

The condensed moist is not the only problem caused by moisture. The insulation surface can be contaminated with certain acids or salts which have property of absorbing moisture. These hygroscopic materials could unpredictably affect the test readings. Therefore, the insulation must be free of such contamination.

Notes:

- It takes time to dry humidity on the tested material when it is moved to test location and that depends also on insulation resistance. Typical times to adopt the tested material to the environment of test location are:
 - at least 2 hours for Riso > 10 G Ω
 - more than 24 hours for Riso > 100 G Ω
 - two days or more for Riso > 1 T Ω

Air ventilation on test location can improve results especially for high humidity environment (>80 % RH).

- Measuring instruments are also influenced by humidity.

As for other electronic equipment, it is strongly recommended not to use the instrument if condensation occurs due to fast temperature changes.

Accuracy above $1 \text{ G}\Omega$ at very high relative humidity (beyond 95 %) can be impaired because of drifting effects in the measuring circuit. More information can be found in technical specification.

- The problem of condensed humidity in the test equipment which occurs when this is moved to test location, is similar to the one mentioned for tested insulation. Therefore, it is also required to wait 4 hours or more to stabilize micro ambient of the instrument.

5.4 Noisy environment, using filters

During the measurements the electrical noise from surroundings may have important influence on measurement results. This noise usually occurs as noise current, reaching values of up to some mA. If we want to reduce the influence of electrical noise, we must determine the disturbing sources. The most important disturbing sources are:

- AC currents of mains frequency and its harmonics, switching transients, etc. that cause the results to become unstable. These currents are mostly coupled through insulation capacitances close to live systems,
- Other currents induced or coupled in electromagnetic environment of tested insulation,
- Ground loops.

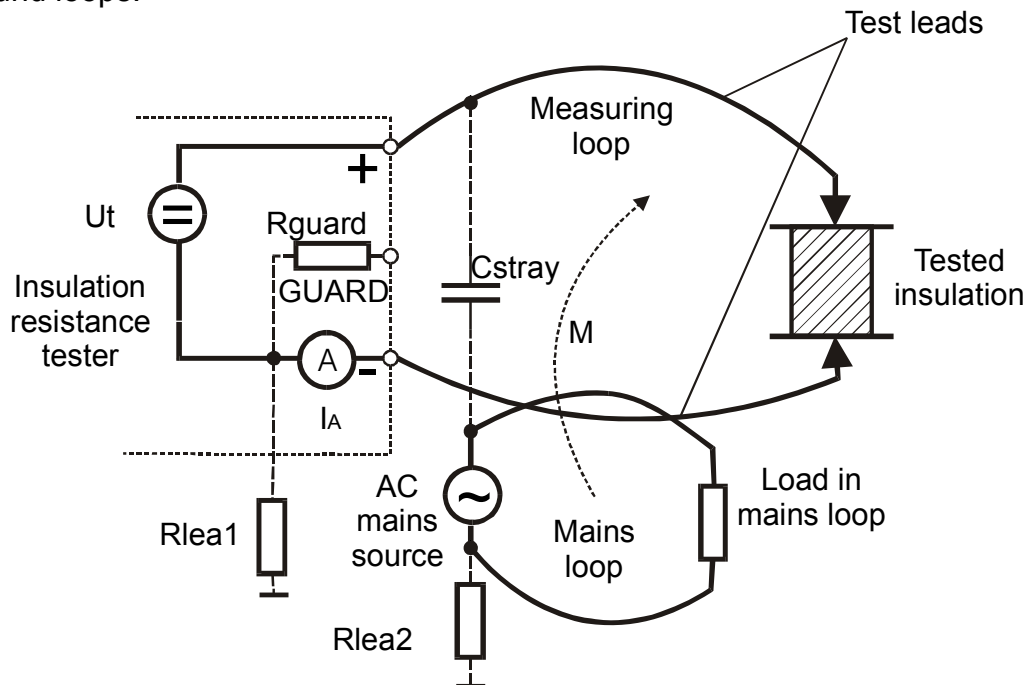

Figure 17: Simplified circuit representing the sources of disturbing currents during insulation test

Figure 17 represents simplified real test circuit during insulation resistance measurement.

Elements have the following meaning:

Ut	a D.C. test voltage of test equipment
Rguard	internal resistance of guard terminal
I _A	measured current
Rlea1	leakage resistance of test equipment and measuring circuit to ground
Tested insulation	see equivalent circuit in Figure 1
AC mains source	mains supply system
Load in mains loop	Loading of AC mains (nonlinear loads generate harmonics)
Rlea2	leakage resistance of AC mains to ground
Cstray	stray capacitance, it is capacitive coupling of disturbing signal
M	mutual inductance, generates induced current in measuring loop.

Use of filters

Noise sources are usually of mains frequency or they fluctuate randomly. Both can be efficiently smoothed by means of averaging and bandwidth reduction.

Averaging is a method that takes more measurements and gives the result which is the mean value of them. Mean value is smoothed and has less variations than individual measurements.

Bandwidth reduction gives improved rejection to noise in frequency band outside of interest. Narrower bandwidth means less noise, and improves the results similar to averaging. Averaging can smooth the remaining noise.

Example with TeraOhm

It offers four different filters:

Filter option	Meaning
Filter Off	Low pass filter with cut off frequency of 0.5 Hz in signal line
Filter 1	Additional low pass filter with cut off frequency of 0.05 Hz in signal line
Filter 2	Filter 1 with increased integrating time (4s)
Filter 3	Filter 2 with additional cyclic averaging of 5 results

Examples of using the filters:

A noise current of 1 mA / 50 Hz adds approximately ±15 % distribution to the measured result when measuring 1 GΩ with TeraOhm.

By selecting Filter 1 option the distribution will reduce to less than ±2 %.

Testing an object with the following parameters:

U_{test} =250 V, I_{noise} = 3 mA, R= 2.4 GΩ, C=220 nF

Filter options give following results:

Filter Off: distribution of results 30 %,

Filter 1: distribution of results 3.5 %,

Filter 2: distribution of results 1.5 %,

Filter 3: distribution of results 0.9 %.

Figure 18 represents results of using different filter options in TeraOhm.

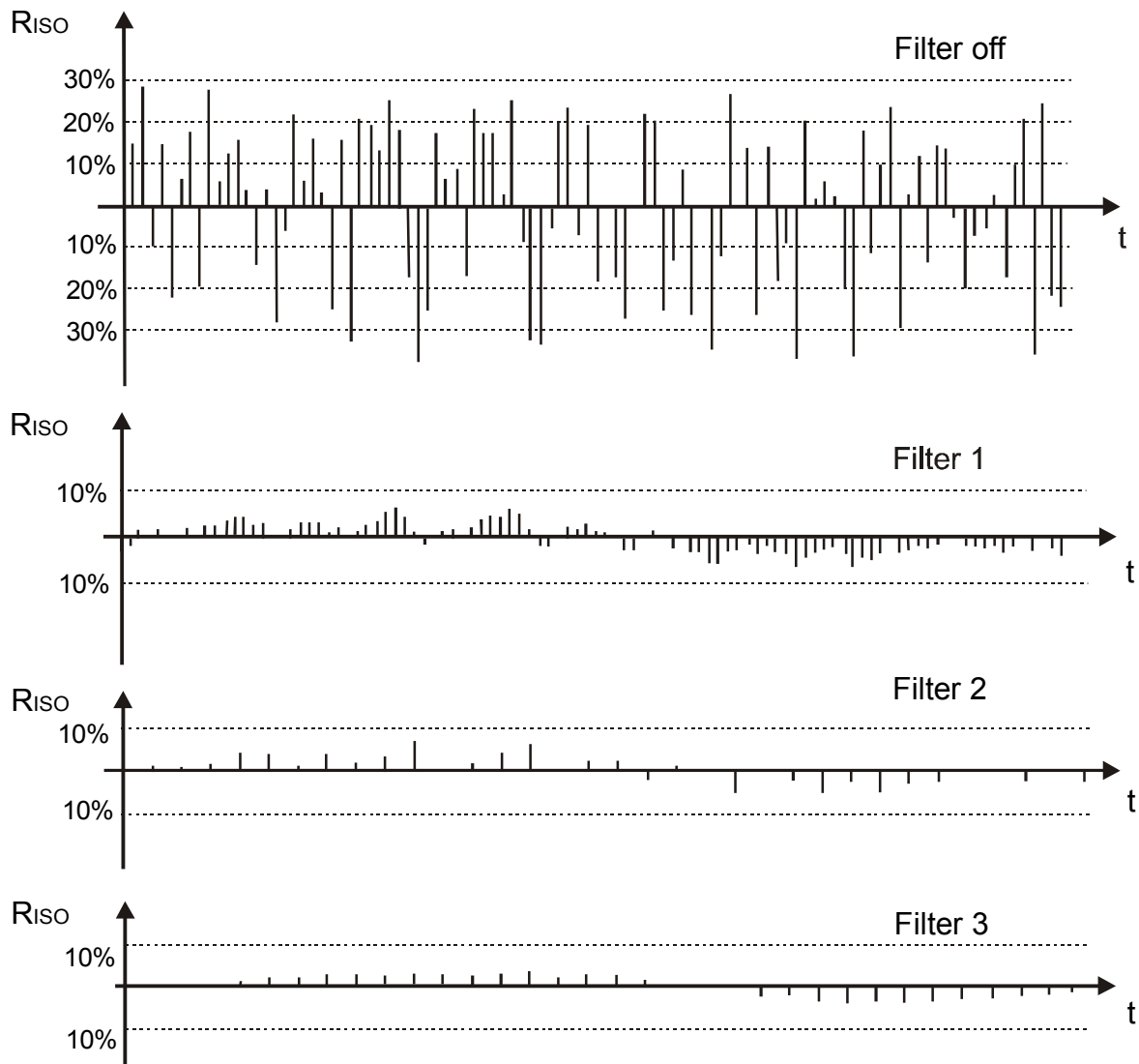

Figure 18: Distribution of test results in noisy environment with different filter options

Note that any of the selected filter options increases the settling time. The settling time represents a period until the results are stable.

5.5 Instability because of high capacitive loads

This instability occurs when measuring items that have a high capacitance compared to their insulation resistance, e.g. $1\mu\text{F}$. Typical capacitive items are long cables or devices with large capacitance, e.g. EMC filters.

There are two reasons for instability.

The first reason is charging and especially charge transfer effects on long cables. For this reason the results take longer time to become stable and the test time for spot test should be increased to several minutes.

The second reason for this instability is the measuring instrument itself. The capacitors cause additional delay in the instrument high voltage regulation loop. Because of the

delay, the voltage becomes slightly unstable. As can be seen from Equation 14, an additional unstable current i_C will flow through the insulation capacitance C_{iso} (Figure 1) and be measured by the measuring circuit. Unlike the initial charging current this current flows all the time and cannot be separated from the leakage current I_{Riso} through the insulation. If it is high compared to I_{Riso} , the results could become very unstable.

$$i_C = C \cdot \frac{\Delta U_c}{\Delta t} \tag{Eq. 14}$$

The instability is quite unpredictable because it depends on many factors (test voltage, R_{iso} , C_{iso} , battery voltage).

In general the results can be smoothed by using averaging filters.

5.6 Instability and accuracy problems of very high insulation results

When measuring very high insulation resistances (above $10\text{ G}\Omega$) any additional parallel resistance paths can become an important disturbing factor. The leakage currents through these resistances are measured by the measuring instrument and this results in too low readings. The sources of additional leakage currents are:

- Resistance between measuring leads, use of improper measuring leads.
- Dirty surface.
- Other resistances between the high measuring lead and the low terminal.
- Resistance between measuring leads and the instrument.

Especially the positive terminal is critical due to very high potential against the measuring instrument and likely to become the source of unwanted leakages.

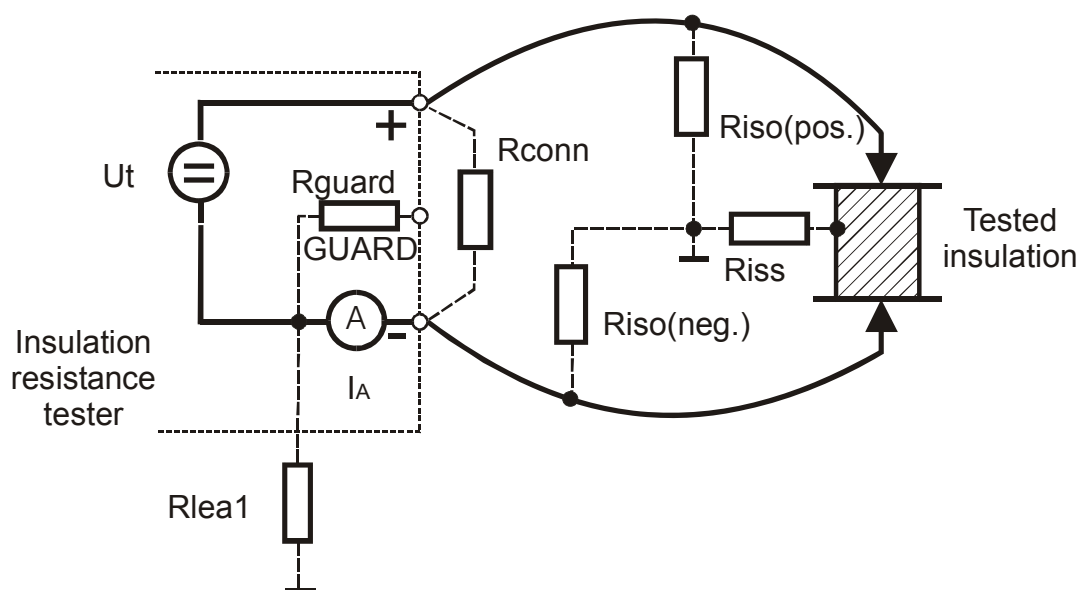

Figure 19: Parasite resistances of measuring circuit

Leakages that influence the insulation resistance measurement:

Rlea1	leakage resistance of test equipment and measuring circuit to ground
Rconn	leakage resistance on connector plate of the test instrument, caused by dirt and humidity on outer side of the instrument
Riso(pos)	Insulation resistance of positive and negative test leads jacket
Riso(neg)	
Riss	Surface resistance of tested insulation

Simple measures can be taken to significantly improve the results:

- Keep the connector plate of the measuring instrument clean.
- Never touch any of the measuring leads (one or both), especially during the measurement.
- The measuring leads should be leaded away from the instruments. This measure will minimize the leakages from the leads to the instrument (a small portion of the current can avoid the guard shield and influence the results).
- Keep distance between the measuring leads.
- If possible, the high terminal should not lie over the item connected to the low terminal.
- Use the guard terminal to lead the parasitic leakages away from the low terminal.
- Use test leads with high quality insulation.

Insulation tester accessories contain special test leads. Standard test leads use dielectric material with lower withstanding voltage and lower insulation resistance.

5.7 Too-low result because of fixed wired and grounded objects

Sometimes the device under test is wired or in contact with other conductive items and additional current paths occur.

This problem often occurs if:

- Fixed installed devices that are wired with others are measured. This is especially critical if the high terminal leads to other objects too. If disconnection is not possible the user must be able to determine the influence of other objects. Refer to *Chapter 4.2* for further information about the determination of device under test.
- The measured object is grounded. There always exist different possibilities to avoid leakages into ground.

See *Chapter 6* for some connection hints.

6. Typical connections for insulation resistance testing

Some typical examples of insulation resistance measurement are shown in the following figures.

Beside the connection always pay attention to:

- safety considerations (refer to *Chapter 4.1.*)
- determination of the tested object (refer to *Chapter 4.2.*).

6.1 Power cables

Figure 18 shows the connection for the measurement of power cable insulation resistance. It is recommended to disconnect cable at both ends in order to measure only the resistance of cable and to avoid possible errors due to leakages across or through switchboards or panel boards.

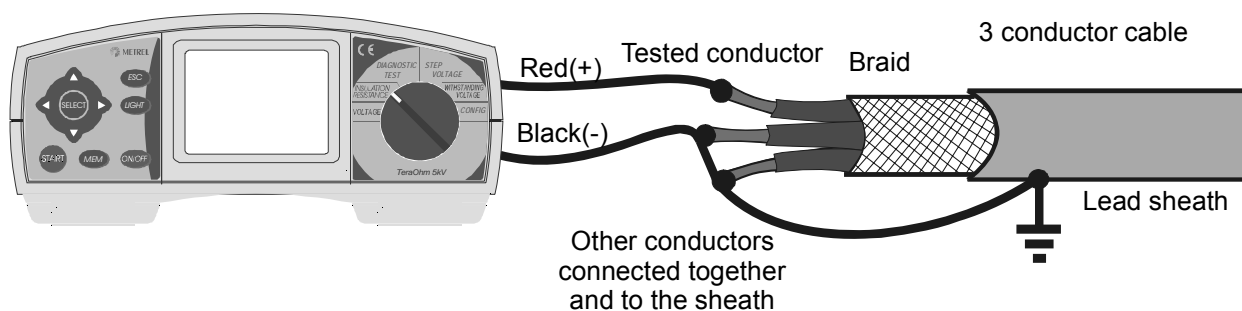

Figure 20: Measurement of insulation resistance of cable between one conductor against other conductors including lead sheath

An error can appear due to leakage currents across the surface of exposed insulation at the ends of a cable. Using the guard terminal as shown in Figure 19 may reduce this error.

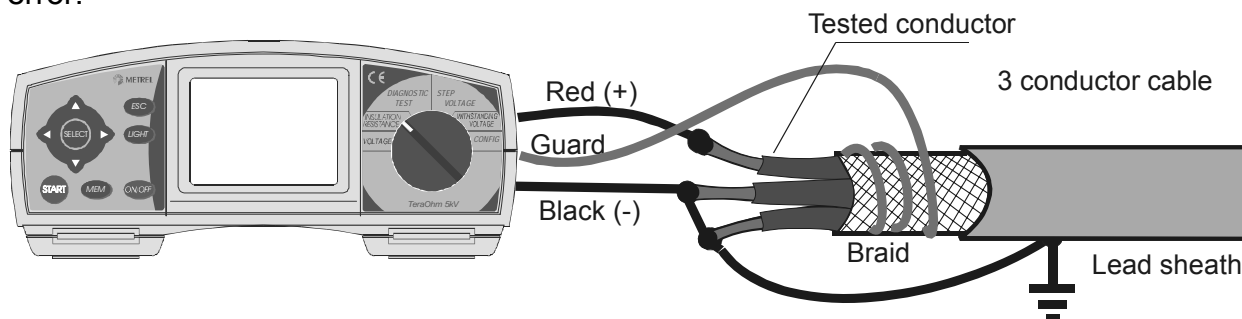

Figure 21: Measurement of insulation resistance of cable between one conductor against other conductors and lead sheath using the guard terminal to avoid leakage effects at the end of cable

It is possible to measure only the insulation resistance between one line and lead sheath. In that case, the guard terminal is wrapped around the exposed insulation and connected to adjacent conductors.

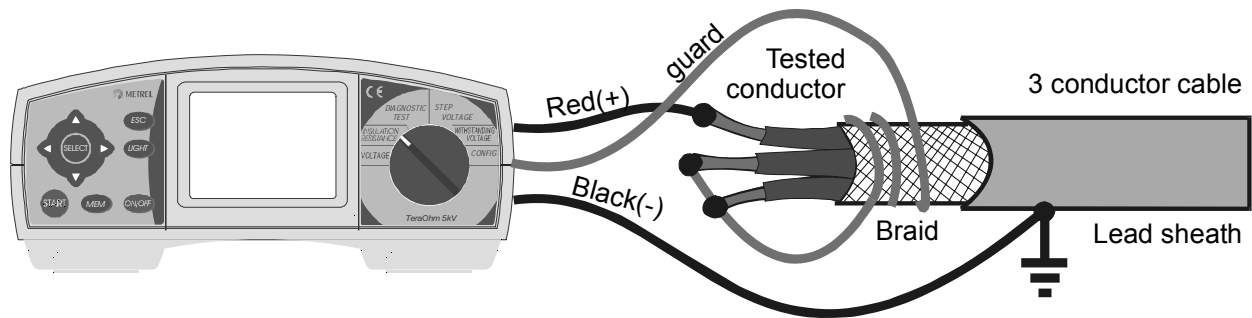

Figure 22: Measurement of insulation resistance of a cable between a conductor and lead sheath

6.2 Control and communication cable

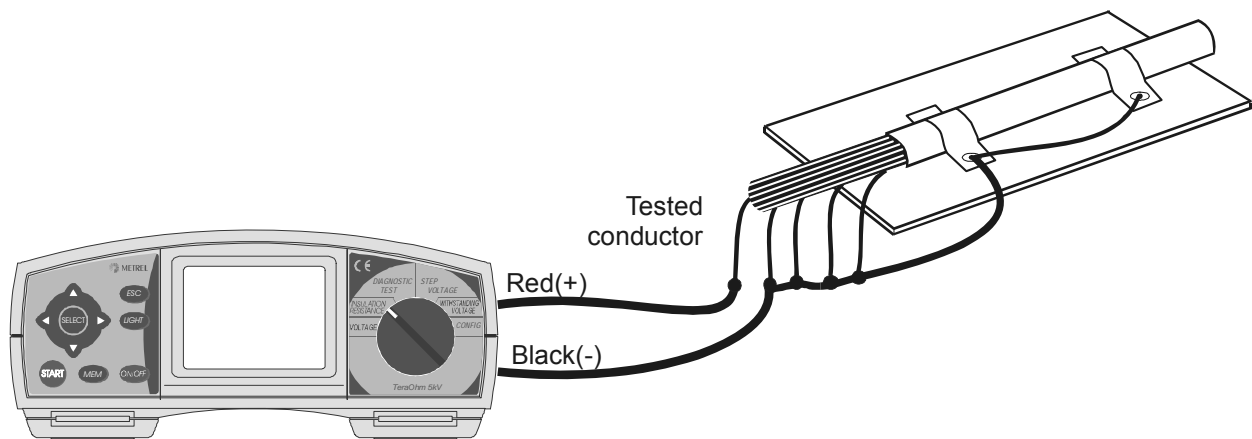

Figure 23: Measurement of insulation resistance between one lead of communication cable against other leads and sheath

Figure 23 shows the connection for testing insulation resistance of one wire in a multi-conductor cable against all other wires and sheath connected together. By using the guard terminal it is possible to measure only the resistance between one wire and sheath (Figure 24) or one wire and other wires (Figure 25).

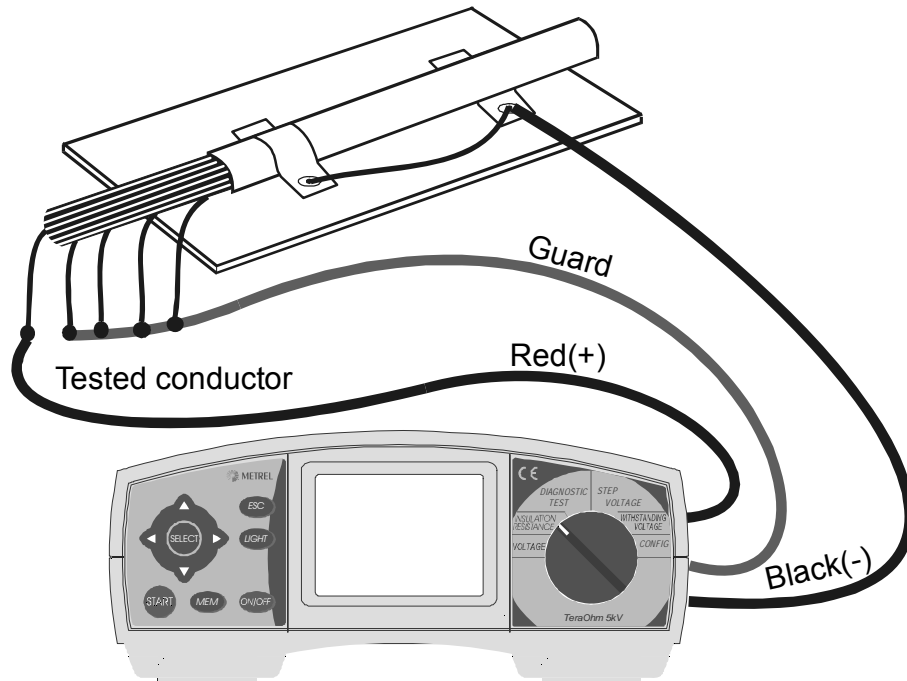

Figure 24: Measurement of insulation resistance of communication cable using the guard terminal. Resistance is measured between a lead and sheath

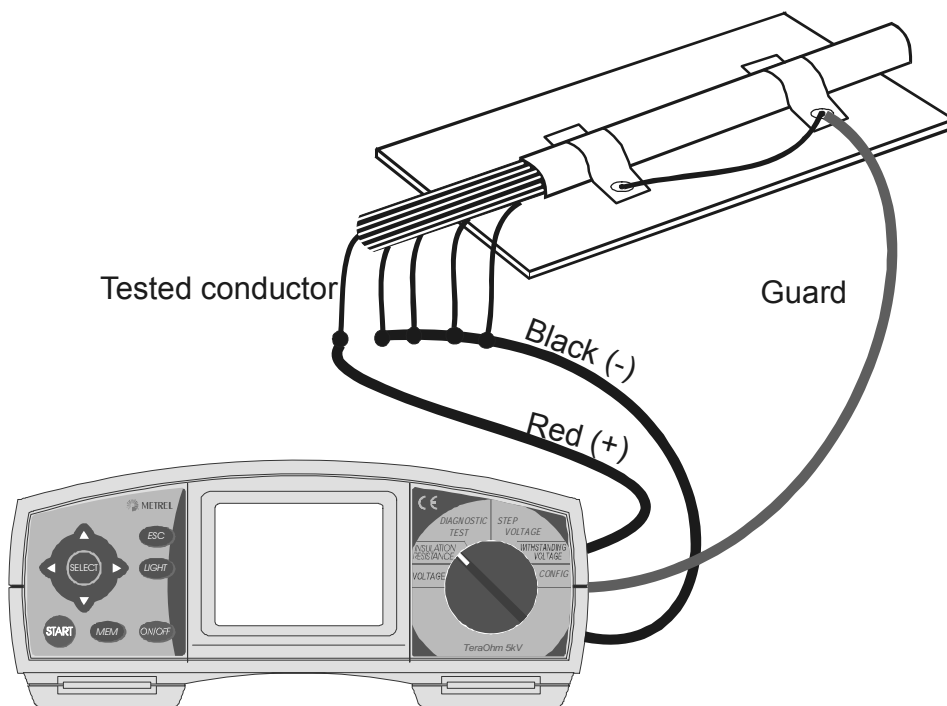

Figure 25: Measurement of insulation resistance of communication cable using the guard terminal. Resistance is measured between one lead and other leads

6.3 Wiring installation

Measuring the insulation of circuit on the distribution panel is shown in Figure 26.

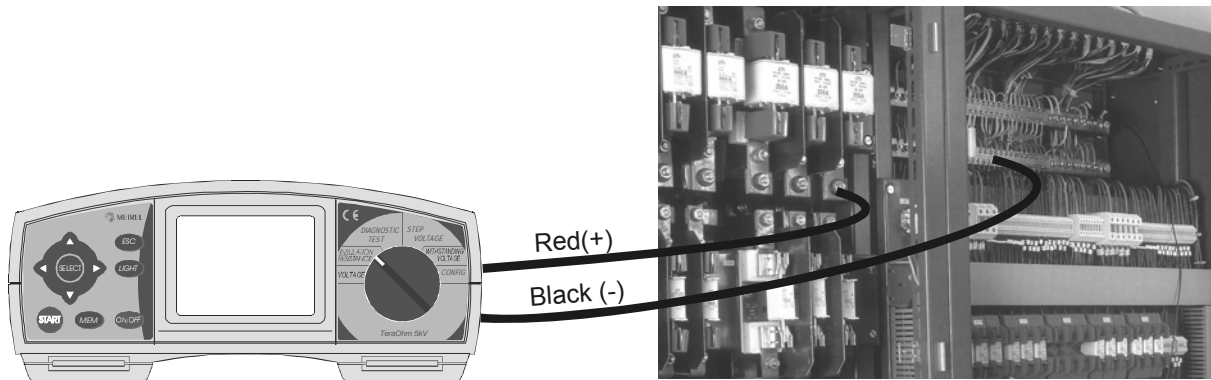

Figure 26: Measurement of each circuit in the distribution panel separately

6.4 Home appliances and similar electrical devices

The device protected by earth terminal (class I) may be tested together with the belonging cable. Test wires are connected to the apparatus on the plug. Each appliance must have power switch turned on and must be disconnected from mains supply, so that a test of all built-in insulation systems, e.g. heaters, motors, valves etc., can be performed.

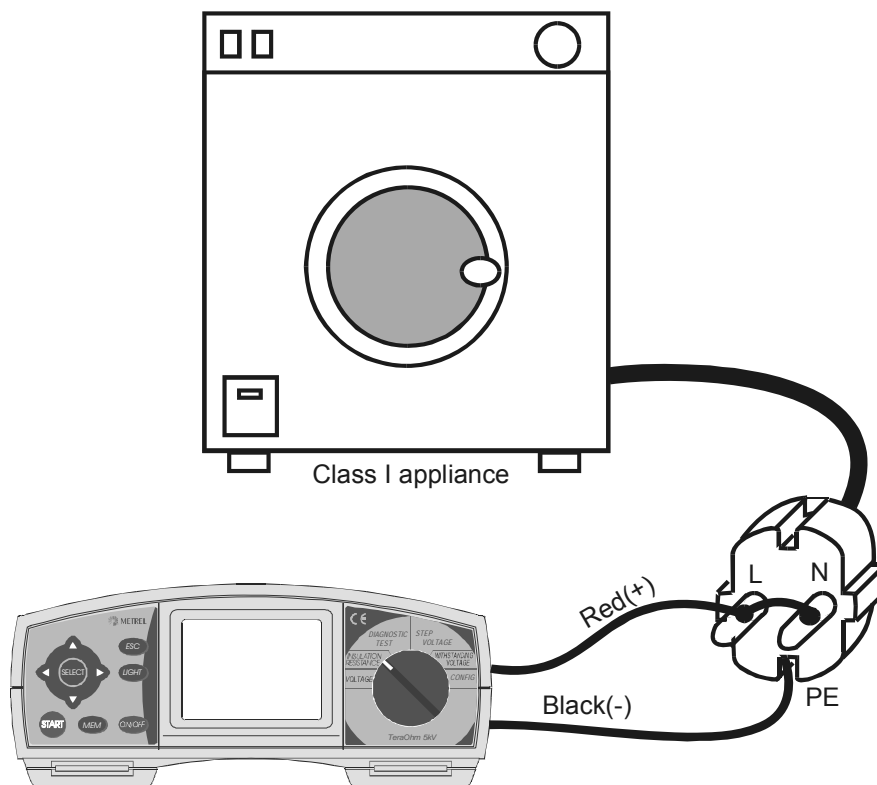

Figure 27: Measurement of household device, protection class I

On the device protected throughout by double insulation (class II) the test leads are connected between the conductor and exposed metal part if any (Figure 28). In both cases, the apparatus must be disconnected from any source of power and placed on some insulating material.

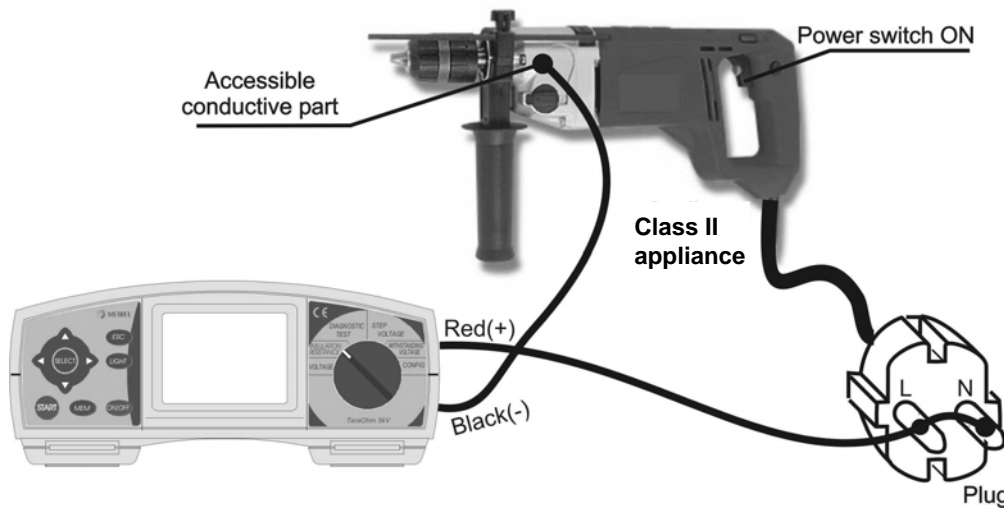

Figure 28: Measurement of household device, protection class II

6.5 Induction motor

Figure 29 shows measurement of insulation resistance between all three phases and earth. In case the measured insulation resistance is high enough no further tests are needed.

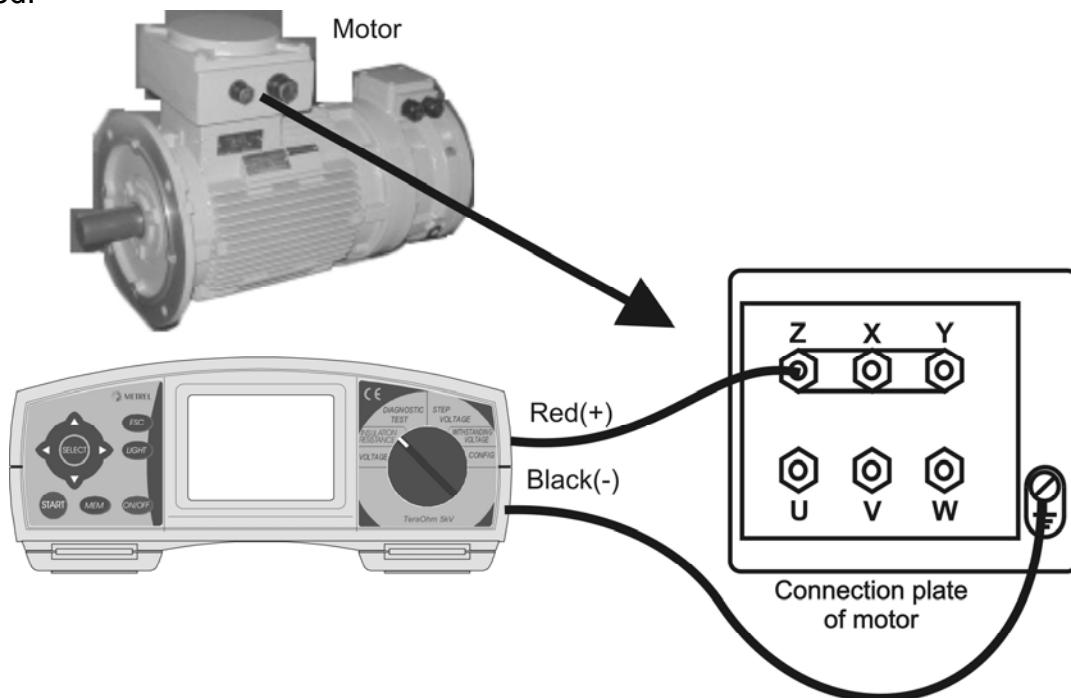

Figure 29: Measurement of insulation resistance of induction motor between all three phases against metal enclosure

If the insulation resistance is too low, each single phase must be tested as shown in Figure 30.

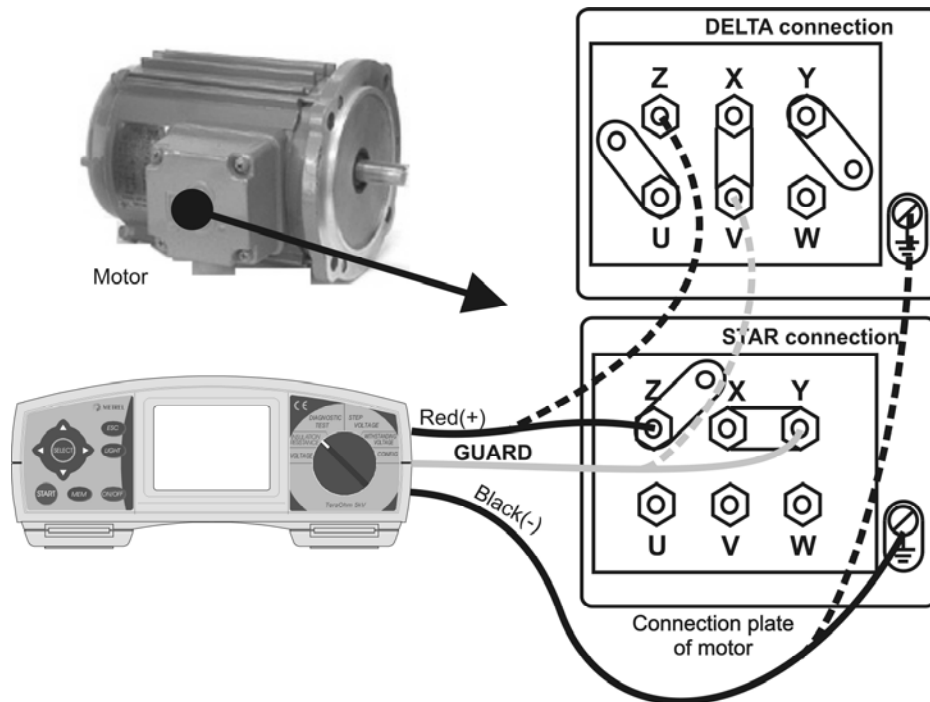

Figure 30: Separate measurement of insulation resistance of induction motor between only one phase and metal enclosure

6.6 Power transformer

The simplest test of transformer is shown in Figure 31. The connecting wires are connected to low and high voltage bus bars on all or only single phase. The result is insulation resistance between parallel-connected transformer high voltage windings, bushings, and the high-voltage disconnect switch and parallel connected low-voltage winding and ground. The low voltage winding is grounded for this test.

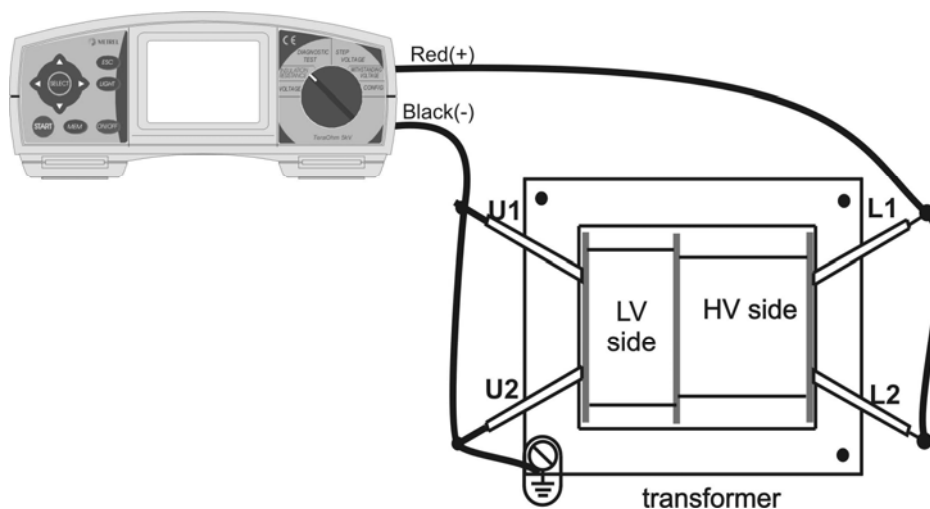

Figure 31: The simplest measurement of insulation resistance of transformer

Using the guard terminal the separate resistances may be measured. Figure 32 presents the connection for measuring resistance between one high voltage winding and earth.

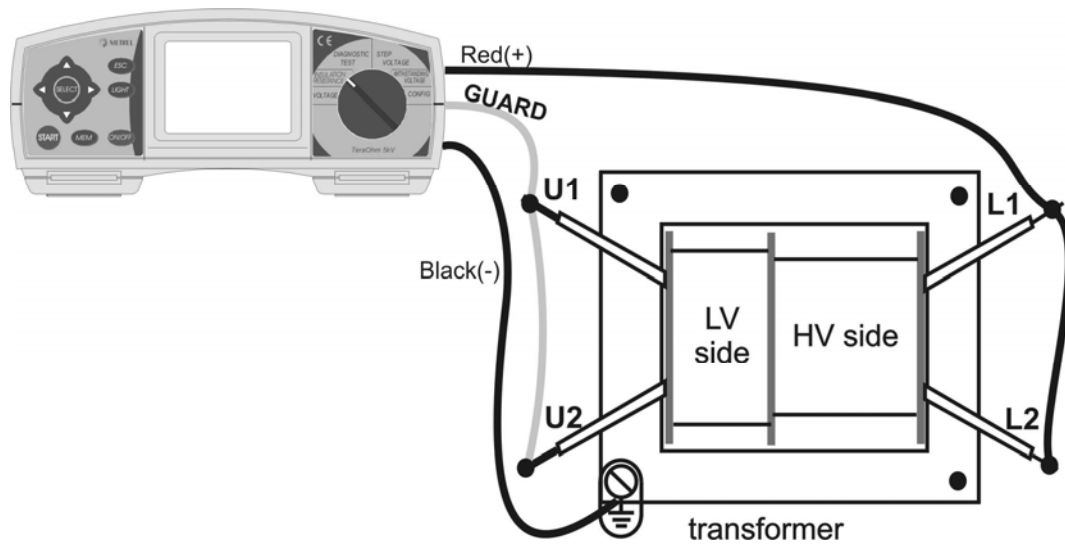

Figure 32: Measurement of insulation resistance on one HV winding against metal enclosure

In the same way, other resistances can also be measured separately.

7. Interpretation of results

The value of insulation resistance from only one measurement does not give us real information about the device. The insulation resistance of the same type of device may be quite different from one device to another. Much more useful is the trend of readings over a time period, showing lessening resistance and warning of coming problems. Periodic testing is the best approach to preventive maintenance of electrical equipment. In the past, only the record cards were used for storing the results and observing the trend of insulation resistance. Modern instruments like TeraOhm enable us saving the results in digital form on computer.

The screenshot shows the TERA-LINK software window with a menu bar (File, Instrument, Configuration, Printout heading, Help) and a toolbar. On the left, a tree view shows a folder '001' containing sub-items '001' and '002'. The main area displays a table with the following data:

n	Location	Function	Results	Parameters	Date Time
1	001	INSULATION RESISTANCE	R = 341 GOhm U = 1046 V I = 3.05 nA C = 0.2 nF Rmax = 341 GOhm Rmin = 201 GOhm	Un = 1000 V timer = 02min00s	24. Jan. 2003 08:42
2	002	INSULATION RESISTANCE	R = 424 GOhm U = 1046 V I = 2.46 nA C = 0.5 nF Rmax = 436 GOhm Rmin = 257 GOhm	Un = 1000 V timer = 02min00s	24. Jan. 2003 08:45

Figure 33: Computer cards in program TERA-Link

The period of testing depends on the importance of a device. In the industry process there are lots of small and cheap parts or machines that are very important for a process in a plant. Such machines must be inspected in a short time to avoid unnecessary disturbance of production process.

The periodic test must be carried out the same way each time. That is, with the same test connections and with the same voltage applied for the same length of time. The temperatures of device and its ambient are very important. It is recommended to make a test at the same temperature each time, if possible. In case that the same temperature cannot be achieved the correction of results has to be done.

The results of periodic insulation resistance test should be interpreted in the right way. There are no exact rules how to interpret the periodic results. Here are only some principle guides how to interpret the results:

Results	Interpretation
High values and well maintained	no cause for concern.
High values, but showing a constant tendency toward lower value	locate and remedy the cause and check the downward trend.
Low values but well maintained	condition is probably good, but the cause of low values should be checked.
Values so low as to be unsafe	clean, dry out, or otherwise maintain insulation before placing equipment back into service.
High values, previously well maintained but showing sudden lowering	make frequent tests until: <ul style="list-style-type: none"> - the cause of low values is located and remedied; - the values have become steady at a lower level but safe for operation; - the values become so low that it is unsafe to keep the equipment in operation.

8. Standards

Most electrical products - equipment, device, apparatus, component - are covered by various general and product standards. Some standards are mentioned in previous text. If standard contains safety provisions, these provisions usually consist of insulation resistance measurement and withstanding test. For specific applications, the measurement of insulation resistance is not enough and it has to be improved with diagnostic test of insulation material to predict its quality and the possibility to be replaced by a new one.

Standards define common test requirements and through this enable the tractability of test results worldwide.

Standards are continuously under development based on new aspects, technical possibilities, methods and materials. However, limit value normally remains the same or tends to sharpen.

Standard	Notice						
IEC 60345 - Ed. 1.0	<p>Method of test for electrical resistance and resistivity of insulating materials at elevated temperatures</p> <p><i>Abstract</i></p> <p>Covers procedures for the determination of insulation resistance and volume resistivity of insulating materials at temperatures up to at least 800 °C.</p>						
IEC 61558-1	<p>Safety of power transformers, power supply units and similar - Part 1: General requirements and tests</p> <p><i>Abstract</i></p> <p>Deals with all aspects of safety (such as electrical, thermal and mechanical) of:</p> <ol style="list-style-type: none"> Stationary or portable, single-phase or polyphase, air-cooled (natural or forced) isolating and safety isolating transformers; Stationary or portable, single-phase or polyphase, air-cooled (natural or forced) separating transformers, auto-transformers, variable transformers and small reactors. 						
IEC 61010-1	<p>Safety requirements for electrical equipment for measurement, control, and laboratory use - Part 1: General requirements</p> <p><i>Abstract</i></p> <p>Specifies general safety requirements for electrical equipment intended for professional, industrial process, and educational use. It applies to 4 main groups of equipment: (a) Electrical test and measurement equipment such as signal generators, measurement standards, power supplies, transducers, transmitters, etc. (b) Electrical control equipment to control specific values by manual setting, programming or by input variables. (c) Electrical laboratory equipment to measure, indicate, monitor or analyse substances, including in vitro diagnostic (IVD) equipment. (d) Accessories for use with the above (for example, sample handling equipment).</p> <p>Examples for DC withstanding test</p> <table border="1"> <thead> <tr> <th>Conditions</th> <th>Test D.C. Voltage</th> </tr> </thead> <tbody> <tr> <td>CAT II 300 V basic insulation</td> <td>1880 V</td> </tr> <tr> <td>CAT II 300 V double insulation</td> <td>3060 V</td> </tr> </tbody> </table>	Conditions	Test D.C. Voltage	CAT II 300 V basic insulation	1880 V	CAT II 300 V double insulation	3060 V
Conditions	Test D.C. Voltage						
CAT II 300 V basic insulation	1880 V						
CAT II 300 V double insulation	3060 V						

IEEE 43:2000	<p>IEEE recommended practice for testing insulation resistance of rotating machinery</p> <p><i>Abstract</i></p> <p>This document describes the recommended procedure for measuring insulation resistance of armature and field windings in rotating machines rated 750 W or greater. It applies to synchronous machines, induction machines, DC machines, and synchronous condensers. Contained within this document is the general theory of insulation resistance (IR) and polarization index (PI), as well as factors affecting the results, test procedures, methods of interpretation, test limitations, and recommended minimum values.</p> <p>Example for selection of test voltage level for devices covered by IEEE 43:2000</p> <table border="1" data-bbox="448 667 1350 875"> <thead> <tr> <th>Winding <i>rated voltage</i> (V)</th> <th>Insulation resistance test direct voltage</th> </tr> </thead> <tbody> <tr> <td><1000</td> <td>500</td> </tr> <tr> <td>1000 – 2500</td> <td>500 – 1000</td> </tr> <tr> <td>2501 – 5000</td> <td>1000 – 2500</td> </tr> <tr> <td>5001 – 12,000</td> <td>2500 – 5000</td> </tr> <tr> <td>>12,000</td> <td>5000 – 10,000</td> </tr> </tbody> </table> <p><i>Rated line-to-line voltage</i> for 3 phase AC machines, line-to-ground voltage for 1-phase machines, and rated direct voltage for DC machines or field windings.</p>	Winding <i>rated voltage</i> (V)	Insulation resistance test direct voltage	<1000	500	1000 – 2500	500 – 1000	2501 – 5000	1000 – 2500	5001 – 12,000	2500 – 5000	>12,000	5000 – 10,000
Winding <i>rated voltage</i> (V)	Insulation resistance test direct voltage												
<1000	500												
1000 – 2500	500 – 1000												
2501 – 5000	1000 – 2500												
5001 – 12,000	2500 – 5000												
>12,000	5000 – 10,000												
IEEE Std C57.12.91-1995	<p>IEEE standard test code for dry-type distribution and power transformers</p> <p><i>Abstract</i></p> <p>Methods for performing tests specified in IEEE Std C57.12.01-1989 and other referenced standards applicable to dry-type distribution and power transformers are described. This standard is intended for use as a basis for performance, safety, and the proper testing of dry-type distribution and power transformers. This standard applies to all dry-type transformers except instrument transformers, step-voltage and induction voltage regulators, arc furnace transformers, rectifier transformers, specialty transformers, and mine transformers. The following tests are covered: resistance measurements; polarity and phase relation tests; ratio tests; no load losses and excitation current; load losses and impedance voltage; dielectric tests; temperature tests; short-circuit tests; audible sound level measurements; and mechanical design tests</p>												

9. Glossary

IEV nnn-oo-pp	The reference to IEC vocabulary IEC 60050 , ©IEC
Insulator	Material, required to prevent the access to or between electrical conductors, circuits and devices, IEV 151-15-39 : device designed to support and insulate conductive material
Insulation resistance - IR	Resistance of insulator, IEV 151-15-43 : resistance under specified conditions between two conductive elements separated by insulating materials
Polarization	Phenomena of generating internal orientation of insulation under electrical field, it acts as charging of capacitance
Polarization index - PI	Ratio between two insulation resistances measured in different time slots during continuous measurement.
Absorption	Phenomena of consuming electrical current during polarization
Dielectric absorption ratio - DAR	Similar to PI, the ratio of two insulation resistances measured in different time slots during continuous measurement, these time slots are shorter than for determination of PI
Withstanding voltage	The voltage applied to insulator that has to be kept without a breakdown.
Guard	A conductive area that makes barrier between two test nodes, it shunts unwanted (mostly surface) leakage currents and bypasses them out of current measurement node.
Leakage	AC or DC current flow through insulation and over its surfaces
Periodic test	A testing procedure scheduled by timetable, e.g. annual test
Type test	A testing procedure for evaluation of product characteristics
Routine test	A testing procedure scheduled in production
Basic insulation	Insulation, the failure of which could cause a risk of electric shock.
Supplementary insulation	Independent insulation applied in addition to basic insulation in order to provide protection against electric shock in the event of a failure of basic insulation.
Double insulation	Insulation comprising both basic and supplementary insulation
Reinforced insulation	Insulation that provides protection against electric shock not less than that provided by double insulation. It may comprise several layers.
Clearance	Shortest distance in air between two conductive parts

Creepage distance	IEV 151-03-37: Shortest distance along the surface of the insulating material between two conductive parts
Flashover	Short arc generated when the insulation does not withstand applied voltage
Breakdown	The failure of insulation to effectively prevent the flow of current, sometimes evidenced by arcing
Class I product	Product grounded through the third pin of mains supply connection
Class II product	Product not grounded through mains supply connection. It has to provide at least double insulation.
Line (L)	IEV 195-02-08: conductor which is energized in normal operation and capable of contributing to the transmission or distribution of electric energy but which is not a neutral or mid-point conductor
Neutral (N)	IEV 195-02-05: Common point of a star-connected polyphase system or the earthed mid-point of a single phase system
Protective Earth (PE)	IEV 195-01-11: earthing a point or points in a system or in an installation or in equipment, for purposes of electrical safety

10. Recommended measurement instruments



MI 3201 TeraOhm 5 kV Plus

5 kV Insulation, Voltage and Faultfinding Tester

- **Automated testing** - PI, DD, DAR calculations with automated resistance ranging (AR). All data is displayed during one single measurement.
- **Fault finding** - Fully programmable step voltage and withstanding voltage test functions to assist in diagnosing faults in insulation.
- **R(t) graph** - Real time resistance against time graph plotting facility to graphically illustrate the response of a material to an applied test voltage.
- **Faster testing** - High 5 mA charging current quickly charges capacitive loads.
- **Accurate** - Selectable noise rejection filters (up to 5 mA) and shielded cables as standard ensure accurate readings.
- **Safe** - High CAT IV, 600 V voltage protection
- **Portable** - Lightweight 3 kg design with carry handle and shoulder strap.

The new MI 3201 TeraOhm 5 kV insulation tester is a portable instrument intended to measure insulation resistance through the use of high voltage DC test voltages up to 5 kV. The large LCD screen allows real-time R(t) graphs to be displayed. Results can be stored and downloaded to a computer via USB and RS232 connections with the help of the optional TeraLink software. The high quality instrument, shielded test leads and quality accessories included in the standard set enables you to perform your testing effectively.



APPLICATION:

- Testing insulation resistance of rotating machinery and cables,
- Production line periodic testing and maintenance,
- Troubleshooting and analysis of all kinds of insulation problems.
- Diagnostic testing

STANDARDS:

Instruments operation:
IEC/EN61557-2
Electromagnetic compatibility:
EN 61326 class B
Safety:
EN 61010-1 (instrument)
EN 61010-031(accessories)



Technical Specification

INSULATION	
Test voltage range	250 - 5000 V
Measuring range	10 TΩ
Voltage steps	up to 5 kV, step by 25 V
Voltage ramp test	yes
Automatic discharge after test	yes
Calculation of DD, DAR, PI	yes
Step voltage testing	yes
Withstanding voltage test	yes
Timer	yes
Leakage current measurement	yes
Capacitance measurement	yes
Short circuit / charge current	5 mA
Guard terminal	yes
Auto adjustment function	yes
Audible warnings	yes
Auto ranging	yes
Shielded test leads included	yes
VOLTAGE	
Voltage test AC/DC	up to 600 V AC and DC
ACCURACY	
Insulation	5 % +3d (to 1 TΩ), 15 % +3d (to 10 TΩ)
Voltage	3 % +4 V
Capacitance	5 % +2d
DISPLAY	
R(t) graphs plotting facility	yes
Back light	yes
Graphic display	LCD
MEMORY, SOFTWARE AND COMMUNICATION	
USB / RS232 downloading	yes
Memory size	128 kB
Software	Optional "TeraLink" software
SAFETY AND PROTECTION	
IP	44
Safety category	CAT IV, 600 V
POWER SUPPLY	
Rechargeable batteries	Included
In-built battery charger	yes
Low battery indication	yes
Battery life	4 h @ 5 kV
DIMENSIONS	
Weight	3 kg
Dimensions	310 x 130 x 250 mm



Real time resistance against time graph plotting facility

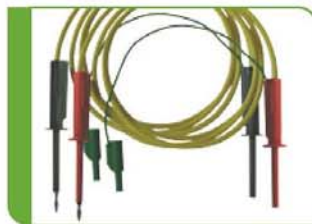

Shielded test leads 12 kV included in standard set.

ORDERING INFORMATION

MI 3201

Standard set



Instrument TeraOhm 5 kV
 Mains cable
 12 kV shielded test lead set, 2 m (black, red)
 10 kV alligator set (black, red)
 Test lead with alligator clip, 2 m (green)
 6 x 1.2 V NIMH batteries, C type
 Handbook "Modern insulation testing" on CD
 Instruction manual
 Product verification data

OPTIONAL ACCESSORIES

Photo	Order No.	Acc. description
	A 1046	6 x 1.2 V NIMH batteries: type C
	A 1275	PC SW TeraLink PRO with USB and RS232 cable
	S 2029	12 kV shielded test lead set, 8 m (black, red)
	S 2030	12 kV shielded test lead set, 15 m (black, red)
	S 2036	10 kV alligator set (black, red)

Note! Photographs in this catalogue may slightly differ from the instruments at the time of delivery. Subject to technical change without notice.



Measuring and Regulation Equipment Manufacturer
 METREL d.d.
 Ljubljanska 77
 SI-1254 Horjul
 Tel. + 386 (0)1 75 58 200
 Fax. + 386 (0)1 75 49 226
 E-mail: metrel@metrel.si
 http://www.metrel.si

MI 3202 GigaOhm 5 kV



5 kV Insulation and Voltage tester



- **Quick setting** - Quick & Easy test voltage selection.
- **Faster testing** - High 5 mA charging current to quickly charge capacitive loads.
- **Safe** - High CAT IV, 600 V voltage protection.
- **Easy to read** - Large, bright LCD display with backlight.
- **Effective testing** - High quality instrument, shielded test leads and accessories (included in the standard set).

The MI 3202 GigaOhm 5 kV provides a quick and accurate reading of insulation resistance. The large segment LCD screen with backlight offers easy reading of results. The analogue/digital display with analogue graph has a range of up to 1 TΩ for insulation resistance and 600 V for voltage measurements. Five test voltages are available.



APPLICATION:

- Testing insulation resistance of rotating machinery and cables,
- Production line periodic testing and maintenance,
- Troubleshooting and analysis of all kinds of insulation problems.

STANDARDS:

Instruments operation:
IEC/EN61557-2

Electromagnetic compatibility:
EN 61326 class B

Safety:
EN 61010-1 (instrument)
EN 61010-031 (accessories)



Technical Specification

INSULATION	
Test Voltage Range	250 - 5000 V
Measuring range	1 TΩ
Voltage steps	250 V, 500 V, 1 kV, 2.5 kV, 5 kV
Automatic discharge after test	yes
Short circuit / charge current	5 mA
Guard terminal	yes
Auto adjustment function	yes
Auto ranging	yes
Shielded test leads included	yes
VOLTAGE	
Voltage test AC/DC	up to 600 V AC and DC
ACCURACY	
Insulation	5 % +3d (to 1 TΩ), 15 % +3d (to 1 TΩ)
Voltage	3 % +4 V
Capacitance	5 % +2d
DISPLAY	
Bar graph	yes
Back light	yes
Graphic display	LCD
SAFETY AND PROTECTION	
IP	44
Safety category	CAT IV, 600 V
POWER SUPPLY	
Rechargeable batteries	Included
In-built battery charger	yes
Low battery indication	yes
Battery life	4 h @ at 5 kV
DIMENSIONS	
Weight	3 kg
Dimensions	310 x 130 x 250 mm



Handle and shoulder strap make the unit easy to carry



Large LCD screen with backlight



Straight forward and fast test setting adjustment



Shielded test leads 12 kV included in standard set

ORDERING INFORMATION

MI 3202

Standard set



Instrument GigaOhm 5 kV
 Mains cable
 12 kV shielded test lead set, 2 m (black, red)
 10 kV alligator set (black, red)
 Test lead with alligator clip, 2 m (green)
 6 x 1.2 V NIMH batteries
 Handbook "Modern insulation testing" on CD
 Instruction manual
 Product verification data

OPTIONAL ACCESSORIES

Photo	Order No.	Acc. description
	A 1046	6 x 1.2 V NIMH batteries type C
	S 2029	12 kV shielded test lead set, 2 m (black, red)
	S 2030	12 kV shielded test lead set, 15 m (black, red)
	S 2036	10 kV alligator set (black, red)

Note! Photographs in this catalogue may slightly differ from the instruments at the time of delivery. Subject to technical change without notice.



Measuring and Regulation Equipment Manufacturer
 METREL d.d.
 Ljubljanska 77
 SI-1254 Horjul
 Tel. + 386 (0)1 75 58 200
 Fax. + 386 (0)1 75 49 226
 E-mail: metrel@metrel.si
 http://www.metrel.si

TeraOhm 10kV MI 3200



Professional insulation tester



Main Features:

- Insulation Resistance measurement up to 10 TΩ,
- Auto-calibration of measuring system,
- Operates from main or rechargeable supply,
- Automatic discharge of capacitive loads,
- Guard terminal to eliminate surface leakage current,
- Digital and bar graph display shows results with date and time,
- User friendly PC software with RS 232 or USB isolated communication port,
- High quality accessories, **12 kV shielded test lead, 10 kV alligator**
- High noise immunity
- Powerful diagnostic tools (PI, DAR, DD, etc)

Technical Specification

Measuring range:	0.01MΩ : 10TΩ	(5% of r. +3 dig.)
Test voltage ranges (DC):	500V : 10000V in steps by 25V	(3% of r. +3V)
Bar Graph Trend:	0 : 1TΩ	
Withstanding test voltage:	500V : 10000V	(3% of r. +40V)
Leakage current range:	0 : 5 mA	(3% of r. +3 dig.)
Voltage AC/DC range:	0 : 600V	(3% of r. +3V)
Capacitance range:	0 : 50μF	(5% of r. +2 dig.)
Polarization index (PI) range:	0 : 99.9	(5% of r. +2 dig.)
Dielectric discharge test range:	0 : 99.9	(5% of r. +2 dig.)
Dielectric absorption ratio range:	0 : 99.9	(5% of r. +2 dig.)

General

Battery power supply:	7.2V DC (6 x 1.2V NIMH, IEC LR20, D size)
Mains power supply:	90 - 260V AC, 45-65Hz
Protection classification:	Double insulation
Over voltage category:	CAT IV 600V
Pollution degree:	2
Degree of protection:	IP 44
Dimensions:	34 X 26 X 16 cm
Weight:	(with batteries, without accessories) 5.5 kg
Visual and sound warnings:	Yes
Display:	LCD dot matrix with backlight (160 X 116)
Memory:	Non volatile internal memory, 1000 measurements with time and date
Working temperature range:	0 : 40 °C
Nominal temperature range:	10 : 30 °C
Storage temperature range:	20 : 70 °C
Maximum humidity:	95% RH (0 : 40 °C) non condensing
Nominal humidity range:	40 : 60% RH

Suitable for:

- Testing insulation resistance of rotating machinery, and cables
- Production line periodic testing and maintenance
- Troubleshooting & analysis of all kind of insulation problems.
- Best suited for industrial environment

Standards applied:

Instrument:
 EN61557-2
 EN61326
 EN61010-1
 IEEE43:2000

Applications:
 EN60345
 EN61010



METREL - Measurement and Regulation Equipment Manufacturer
 Ljubljanska 77, SI-1354 Horjul
 Tel. +386 1 7558 200; Fax: +386 1 7549 226
 web page: www.metrel.si
 e-mail: metrel@metrel.si

METREL d.d.
Measuring and Regulation Equipment Manufacturer
Ljubljanska c. 77, SI-1354 Horjul
Tel: + 386 (0)1 75 58 200 Fax: + 386 (0)1 75 49 226
E-mail: metrel@metrel.si <http://www.metrel.si>

